

EX LIBRIS

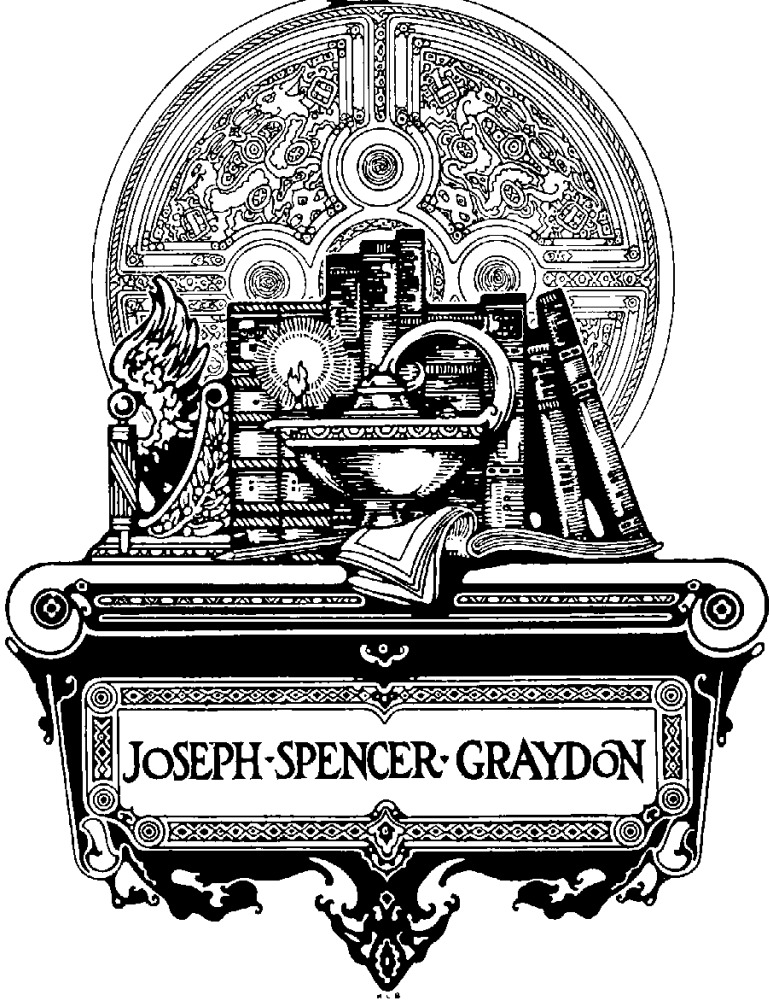

JOSEPH SPENCER GRAYDON

THE PUBLIC LIBRARY  
OF CINCINNATI  
AND HAMILTON COUNTY

---



---

*The Gift of*  
THE ESTATE OF  
JOSEPH S. GRAYDON



# UNIVERSITY FOOT-BALL

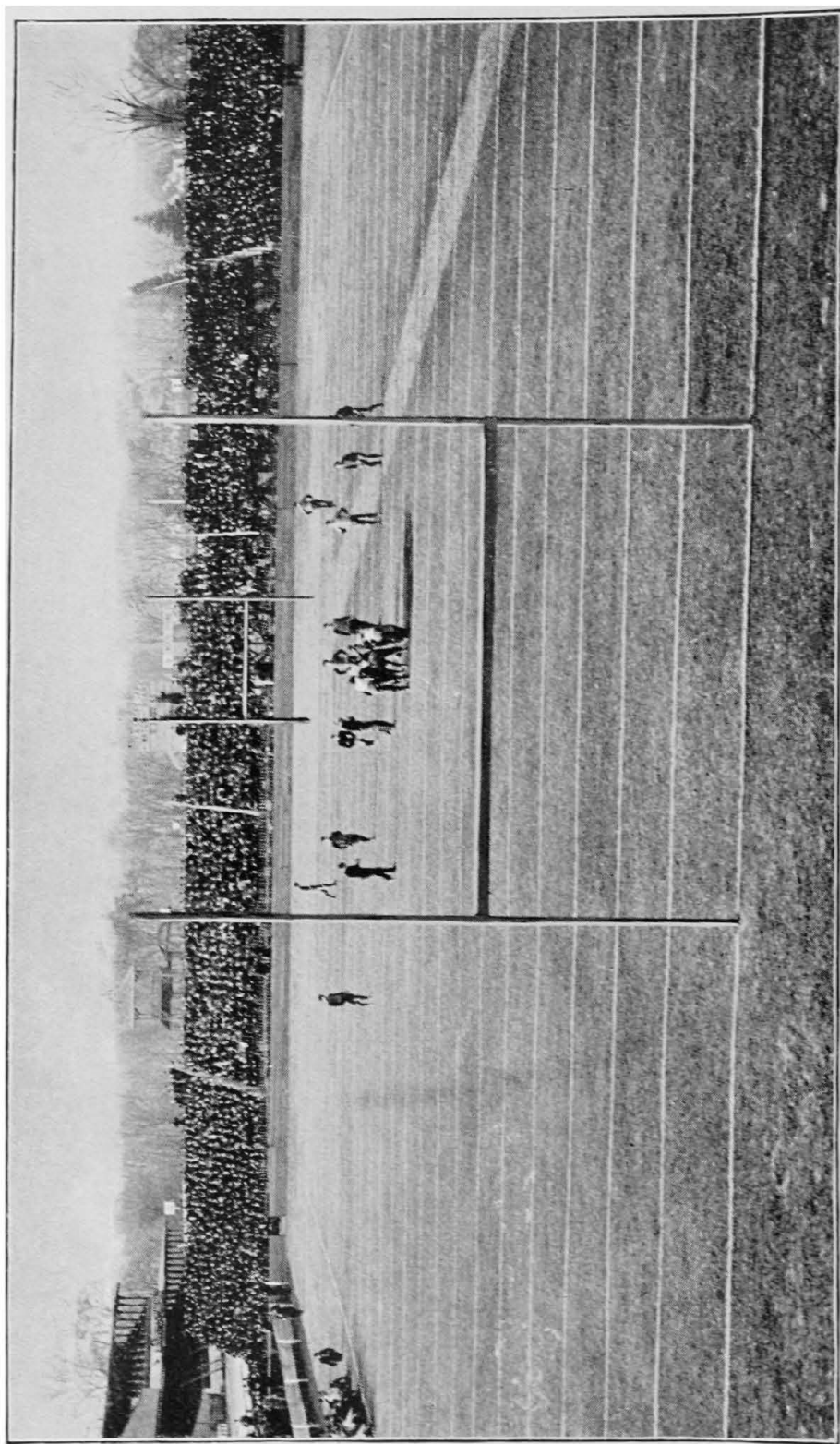

“PLAY P”





UNIVERSITY FOOT-BALL

Harvard Athletic Assn.,  
Cambridge, Mass.

THE PLAY OF EACH POSITION TREATED  
BY A COLLEGE EXPERT

EDITED BY

JAMES R. CHURCH

*WITH PORTRAITS AND ILLUSTRATIONS OF PLAYS*

NEW YORK  
CHARLES SCRIBNER'S SONS

1893



**COPYRIGHT, 1893, BY  
CHARLES SCRIBNER'S SONS**

## PREFACE

---

THE fact that there is so little connected writing on the subject of Foot-Ball has induced the editor to collect the views of some of the leading university players of the day and place them in book form.

If they shall prove of interest to those skilled in the game, or an aid to those beginning it, he will feel repaid for his work.

For the illustrations he is indebted to Mr. Philip King, Pach Brothers, Messrs. Gilbert & Bacon, and Mr. H. C. Smith.

GARFIELD MEMORIAL HOSPITAL,  
WASHINGTON, D.C.,  
July, 1898.



# CONTENTS

---

	PAGE
FOOT-BALL GENERALLY CONSIDERED . . . . .	
<i>James R. Church</i>	1
THE WEDGE: ITS DEVELOPMENT AND USE . . . . .	
<i>W. M. Irvine, P.</i>	15
THE END-RUSHER . . . . . <i>F. W. Hallowell, H.</i>	35
THE TACKLE . . . . . <i>Wallace C. Winter, Y.</i>	41
THE GUARD . . . . . <i>Hector W. Cowan, P.</i>	51
CENTRE-RUSH . . . . . <i>W. J. George, P.</i>	59
QUARTER-BACK . . . . . <i>Edgar Allan Poe, P.</i>	71
HALF-BACK . . . . . <i>James P. Lee, H.</i>	79
FULL-BACK . . . . . <i>W. T. Bull, Y.</i>	91
TRAINING . . . . .	103
THE REFEREE AND UMPIRE . . . . .	109
RULES AND CONSTITUTION . . . . .	113



## LIST OF ILLUSTRATIONS

---

### PORTRAITS

	OPP. PAGE
W. M. IRVINE . . . . .	15
F. W. HALLOWELL . . . . .	35
WALLACE C. WINTER . . . . .	41
HECTOR W. COWAN . . . . .	51
W. J. GEORGE . . . . .	59
EDGAR ALLAN POE . . . . .	71
JAMES P. LEE . . . . .	79
W. T. BULL . . . . .	91

### ILLUSTRATIONS OF PLAYS

PLATE I.	“Play!” . . . . .	<i>Frontispiece</i>
		OPP. PAGE
PLATE II.	Interference . . . . .	6
PLATE III.	The Wedge . . . . .	18
PLATE IV.	A Run around the End . . . . .	38
PLATE V.	A Wedge on Tackle . . . . .	44
PLATE VI.	Putting the Ball in Play . . . . .	66
PLATE VII.	A Run through the Line . . . . .	82
PLATE VIII.	After a Kick . . . . .	100



# UNIVERSITY FOOT-BALL

## FOOT-BALL GENERALLY CONSIDERED

BY JAMES R. CHURCH

As a nation with an English strain in its blood, we to-day show perhaps the effects of heredity, in our fondness, growing with each succeeding year, for out-door sports and training; and with such ancestors it seems natural that the national game of our British cousins should rank high in public favor. Like true "Yankees," however, with a tendency toward the betterment of an existent régime we have so far modified the Rugby foot-ball that little remains of the original game. Taking the English game as the starting-point, each successive crop of American university players has added to, and subtracted from it, until we may, save the first idea, claim originality for our system of play.

Our foot-ball of to-day — that is, the Rugby



game — dates back to 1876 in this country, when the first game was played at New Haven. An association had been formed in England some five years previously, under a common ruling, and from this as a matrix sprang our intercollegiate game of to-day.

The essential difference between the two systems now, as it was at first, is our systematization of the play behind the line, of making the outlet from the scrimmage, or the snap-back a preconcerted arrangement, and involving certain men and certain duties. In the game as first adopted here, the ball came out from no definite point, at no assigned time, being kicked out by some one of the opposing rushers and taken indefinitely by one of the backs. A little experience showed that it was good policy to allow the ball free motion instead of opposing the kick, and the further fact was soon demonstrated that a rusher could himself kick or snap the ball back and add to the chances of his own side.

Here began the divergence of the two styles of play; at first the modification was naturally crude, the duty of putting the ball in play devolving on no special one of the line, and the receiving back having no definite

positional value. The line men had no assigned positions, and the game was one of chance instead of the nicely balanced competition of skill and trickery which marks a contest to-day.

At our start in the sport the number of players was eleven; after a year or two, for some unassignable reason, possibly as a protective measure, the force was increased to fifteen, a move directly in opposition to the English policy, which had reduced the number of players from twenty to fifteen. No great time was necessary to demonstrate the inutility of the move, and the original complement was again returned to.

The first game in 1876 was played without settled rules, and the confusion resulting demonstrated the necessity of a definite understanding as to at least the fundamental points of the game; before the next season a convention had met and drawn up a set of rules which have been the nucleus of the present laws. As in the case of all laws, the establishment of any, brought out the possibility of evading the spirit without an absolute infringement, and the necessity of additions and corrections to check the evasion. This

was particularly evidenced in the notorious "block game," where before the necessity for a definite loss or gain, or a penalty, the side in possession could hold the ball for an indefinite time. One large game under this style of play showed that to hold public interest something must be done to break up the "block" play. The five-yard gain or twenty-yard loss in three downs settled the question to the satisfaction both of the public and the players.

The next point which disturbed the serenity of the authorities was that of interference, a most distinctively American feature of the game. Although a certain amount of this kind of play had been tacitly recognized, the growth of interference in the rush-line during a scrimmage brought forward the necessity of some kind of a limitation: when it came to such a pass that opposing rushers could hold each other, or impede the advance by joining arms, restricting laws were passed which denied to the side having the ball the use of hands and arms in interference.

For a time much trouble arose from the fact that the referee was overburdened by his duties, and the two umpires, in reality

field captains, whose duties were to make claims for their respective teams, added to his distraction by their constant calls and claims of foul. After their abolition, his duties were easier, but the patent fact remained that to have fair and clear rulings a further division of labor must be made. At this juncture the umpire was introduced, who relieved the referee of all care of fouls, and made him simply a judge of play, all other decisions being rendered by his confrere. Even with this added force it is now sometimes questionable as to whether it would not be well to have touch judges as in the British game.

The greatest point in the advance of the modern game has been the development of interference, which under its many forms really comes down to *team play* as its starting-point: the combination of eleven men, or a majority thereof, as against individual effort.

Interference proper, in the advance of the ball, does not date back a great way in the history of the game, coming into prominence first about 1886. At that time it was generally limited to the efforts of one man to aid a comrade, — a sort of crude tandem play,

with no idea of the carefully studied and often brilliantly executed interference plays of to-day.

As soon as it was seen that one man could be used to advantage as a fender, the leading teams began to build up this system of advance, and the result is the unison of action, the correlation of players, which makes the interference of to-day.

In order to understand how thoroughly this system is carried out now, we may cite a play in which the combined forces unite to advance, all the strength concentrated on the focal point, the ball.

Suppose we take a team lined up and under instructions for a run round the right end, by the left half-back. At the instant the ball is snapped, the full-back and right half start, shoulder to shoulder, ahead of the runner, who follows well at their heels with the quarter-back beside him, next to the line (see Diagrams 1 and 2, page 12, and Plate II.): if the team plays the "box the tackle"<sup>1</sup> game, the quarter takes the un-

<sup>1</sup> In "boxing the tackle," the tackle and end of the offensive side combine against the opposing tackle, leaving the end on that side free.

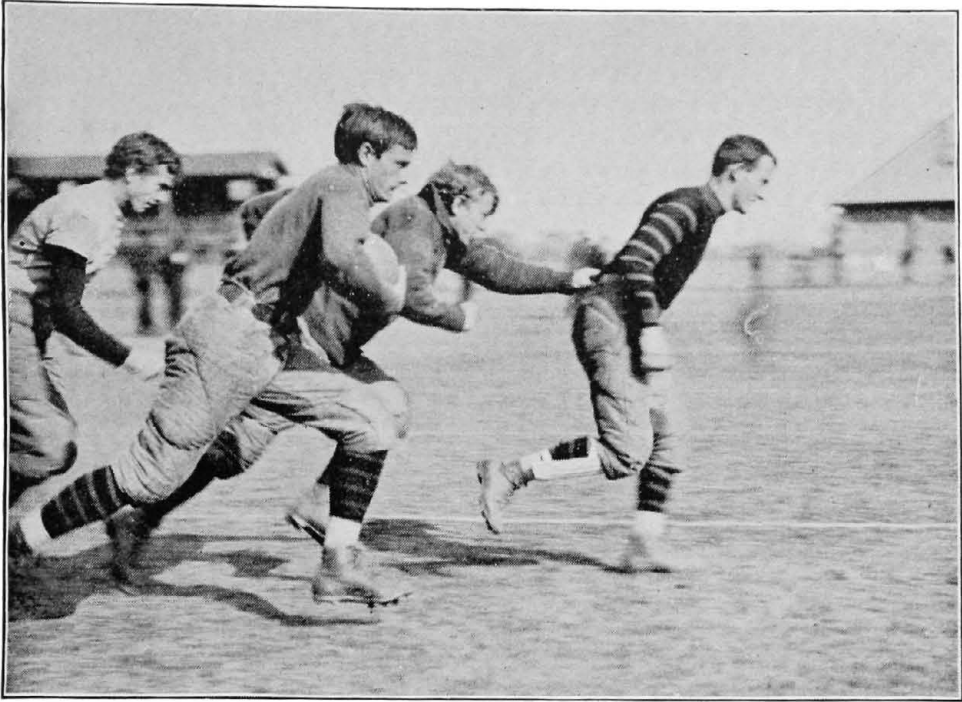

INTERFERENCE

Illustrating the position of the man with the ball in reference to the other backs who act as interferers for him



guarded end-rusher, and the left half goes on behind the protection of the right half and the full-back. Simultaneously with the starting of the quarter, the right guard wheels and follows him, the other rushers to his left coming after, and the whole line excepting right-tackle and end, who are penning the opposing end, forms a moving wall toward the objective point of the play, shutting off by their presence the attacks of would-be tacklers.

The diagrams will serve to show the formation both before and after the signal, as it should be theoretically. Of course no one given play can conform exactly to the ideal, but it is the close approximation of theory to practice, and the constant exertion to carry out a systematic line of play under given conditions, which brings out to its best development true interference.

One common fault in green men in interference, is their liability, after they have fulfilled the primary duty in the play, to drop out of the play and string out in the background. This should never be allowed, since a man may often get in as good secondary interference as primary; and if the play be



checked, his weight at the back may count for the yard, the foot or the fraction which so often counts either a touch-down or a first down.

In runs by the full-back, or around the other end, the same relative position of course exists, and just as much material is used to insure the success of the play.

In runs through the line, say between right guard and tackle, by the left half-back, the right half and the full-back may be thrown through ahead as a break, the running half and the quarter following close in their wake, and the left guard coming in behind with their "beef" as a minor wedge-formation.

The fundamental idea in all interference plays is essentially the one of a close formation of players arranged after such an order as to render the man with the ball inaccessible to his opponents: by just so much as the players string out, by just so much as they are loose in their formation, slow in their start or running, by just that much do they detract from the object and efficacy of the play.

A play once settled on should be rehearsed many times in practice, the men at first walk-

ing from their places to the positions they are to occupy, and gradually increasing their speed until, with no opposing rush-line, they can go through the manœuvre with speed and *clock-like regularity*. After system is acquired, the element of a line to contend against may be added, and the whole worked up until each individual knows just about what difficulties he will have to contend against, and has solved, to his own satisfaction, the way of overcoming them. Unless the team be drilled to quick play of this sort in practice, it can never attain to it in a game; for it is a well-recognized fact that a captain can call upon his team for fast play up to the limit of that reached in practice, but beyond that he cannot go without danger of misarrangement and confusion. It is better, far better, to expect moderately rapid work with *system*, than fast play which savors of individuality and is confused. In no part of play is a "coach" so sorely needed as in the guidance of interference; for be it ever so well planned, there is almost invariably some man who will lag at a certain point in his duties, and such a fault increases with its constant execution and is dispelled only by

constant cussing from a lynx-eyed director, watching for fault rather than perfection.

New as it is, interference has developed a variety of formations, a number of combinations of the eleven men participating therein: the examples quoted are only two of many, but with an understanding of the principle which underlies the whole system, any clear-headed captain can work out to his satisfaction those he wishes to use.

To the average uninitiated spectator, a game of foot-ball looks like the veriest hurly-burly of chance and main strength: were he told that the ball never left the hands of the quarter-back until its destination and the nature of the play to follow had been clearly announced to the entire team, he would smile with incredulity. Yet such is the case: the captain reigns over the seeming disorder and directs each advance in the channel which seems most liable to yield a gain.

As the other features of the game have been developed, the system of signalling has kept pace, until now the movements of a team in play are directed by a system in comparison with which Poe's Cryptogram would be child's play.

At first "phrase signals" were in use; that is, a certain set of words standing for a certain play: their easy comprehension, however, by the opponents led to their early abolition, and other systems followed, each a little more difficult of interpretation.

As an illustration of the later signals, one example will serve to show how they have been developed. During the past few years the "letter" and "number" signals have been in vogue, and the appended set is only one of the many possible combinations.

In this case letters are used, and each running man on the team is lettered, and each space also, as shown in the diagram. Next a "catch-letter" is chosen, being the key to the cipher. Suppose E is taken. In signalling by this system, any number of letters may be used to cloak the signal, and the ears of the team are open only for the catch-letter and its two consequents, the first of them denoting the opening, and the second the runner. In the signal *A B C N E A C M* the letters italicized are the significant ones, and reference to the diagrams, No. 1 and 2, show that they call for a run by the left half-back around the right ends. In signalling a kick, the catch-

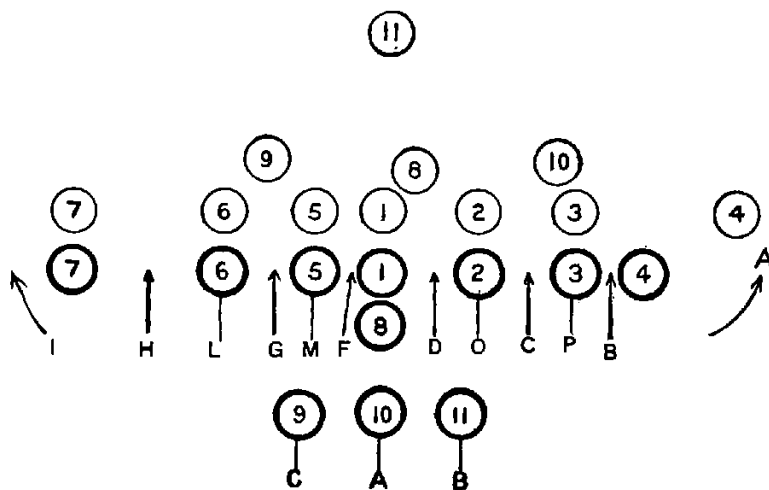

DIAGRAM No. 1.

“Letter” system of signals; scheme of lettering openings and players. The arrows indicate the running spaces, the other letters the men, 3 and 4 on the lettered side are “boxing” the opposite tackle.

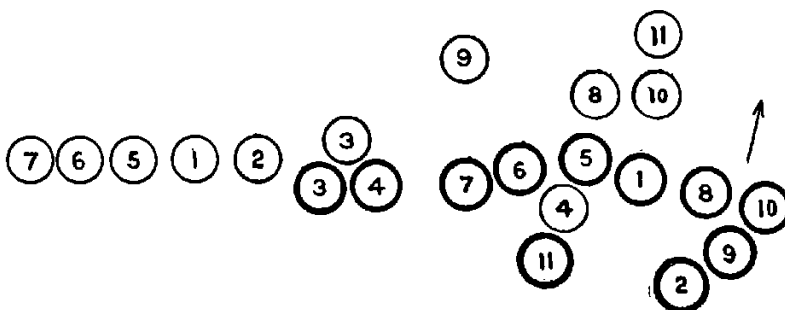

DIAGRAM No. 2.

“Letter” system of signals; result of signal A B C N E A C M; the left half-back taking the ball around the right end.

letter is omitted entirely and any letters used.

Of course any number of variations are possible, and a team may be drilled to two catch-letters in order that one may be changed in event of the opponents "getting on to" the system. This is only one of the many ways of directing a team in action, each year bringing out what appears to an outsider like a more and more hopeless jargon, but in reality a carefully concealed scheme of command. With all the skill used to cover the systems it is wonderful how often an old player will fathom the mystery, and to his opponents' disgust, announce to his own side the contemplated move as soon as the signal is issued.

Little by little, from a modest beginning, the game of American foot-ball has grown up into popular favor, until now it holds a large part of public attention during its fall season; many things have come up which have threatened to oust it from its place, but each one has been met by judicious legislation, as the future difficulties which must come with further advancement will be.

To any one who has played the game, to

any one who has associated with foot-ball men, its value as an educational feature in its own sphere and place must be apparent.

To be good in the game one must be in perfect physical health, must develop pluck and endurance, patience unending, and absolute self-control. Coming in a young man's life when these are traits and qualities needful of exercise, why should we wish for a better, a manlier, or a more innocent method of their development?





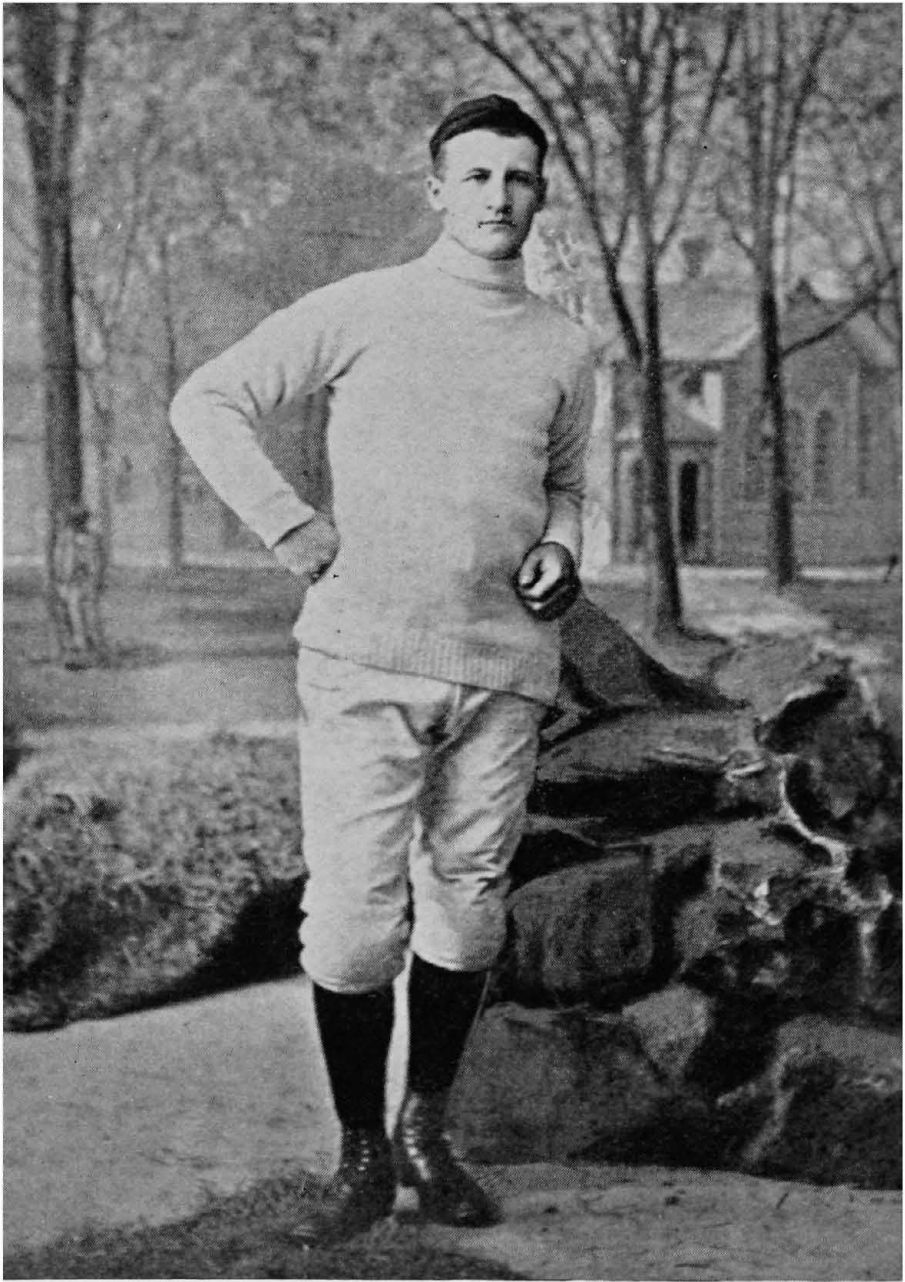

William Mann Irvine.  
——— " ———

## THE WEDGE: ITS DEVELOPMENT AND USE

BY W. M. IRVINE

DURING the first ten years of Rugby football in America—we now wonder at the folly of it—the runner who carried the ball from the kick-off was sent *ahead* of the other players of his own side. He ran unprotected, depending on his ability to dodge; also expecting, in case he was tackled, to pass the ball back to one of his companions, who in turn should try to advance it. In those days tackling was not a fine art; men tackled individually, and not in pairs or bunches. The last use of this foolish style of play by a 'Varsity team was in the Yale-Princeton game played in New Haven, in November, 1885. Cowan, Princeton's giant rusher, at the kick-off, was started ahead of his team with the ball. The fierce, low tackling of Peters and Woodruff felled the Princetonian before he had gained five yards.

The first step toward improvement in starting the play at kick-off was a sort of unorganized interference. Instead of following the runner, each rusher of the side which carried the ball ran ahead and disconcerted his opposite rusher by bumping or toppling over the latter. This plan of attack was especially well carried out by Yale in the days when Gill and Beecher were the star runners and dodgers of the Blue. From this system of individual interference, one year later, sprang the idea of team interference at the kick-off — the genesis of wedge-play.

The first team to use wedge-play, so-called, was the Princeton eleven, of 1886. The credit of this play, as perfected at that time,

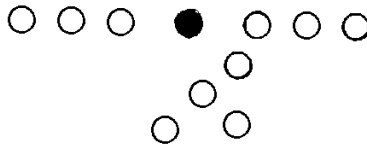

FIG. 1.

is due to Mr. Richard M. Hodge, the Princeton quarter-back of that year.

The wedge was known as “the straight V.”

The fundamental purpose of the V was to cleave the opposing rush-line, and thus give

the runner a clear field until he reached the backs. (In this chapter, the darkened circle will always be the man who carries the ball.) The players build up as in Fig. 1. The instant the ball was snapped, the centre rusher ran straight ahead at full speed, and

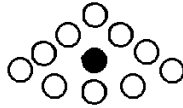

FIG. 2.

the other six rushers ran in and forward, protecting the runner, as in Fig. 2.

In running a straight V, the centre rusher must aim merely to graze the side of his opposite. If he strikes the latter "amidships," the apex of the V is stopped, the sides are broken, and the runner is unable to extricate himself. Each rusher in the sides of the V must see to it that no opponent gets through the V between the centre and himself. The opposing line once broken, the V opens, and the runner thence takes care of himself. In 1886 Princeton played this V in practice daily, using it, for the first time in a match game, against Harvard. Ames, who carried the ball, was not stopped until

he had reached Harvard's twenty-five-yard line. Harvard, the following year, used the same wedge, running it in an oblique direction, to right or left, as advantage might offer. Yale further modified the straight V by arranging the players in V shape, before the ball was dribbled, each rusher placing his hands on the hips of the man in front (see Plate III.). The straight V can also be run, using the tackle as apex, and the backs to fill out one side of the V.

The second form to appear in the evolution of the wedge was the "shoving" wedge of Yale. In the fall of 1887 Princeton tried this style of wedge in practice. Princeton's captain, however, thought that the "shoving" wedge "broke up" too many men, and its use was discontinued. In 1888 Yale perfected this style of wedge and used it with telling effect, especially against Harvard. The "shoving" wedge is used for short gains, generally near the goal-line. Before the ball is snapped, the players of the side in possession of the ball arrange themselves as in Fig. 3.

Hands are placed on shoulders in front, and the instant the ball is snapped, the wedge

PLATE III.

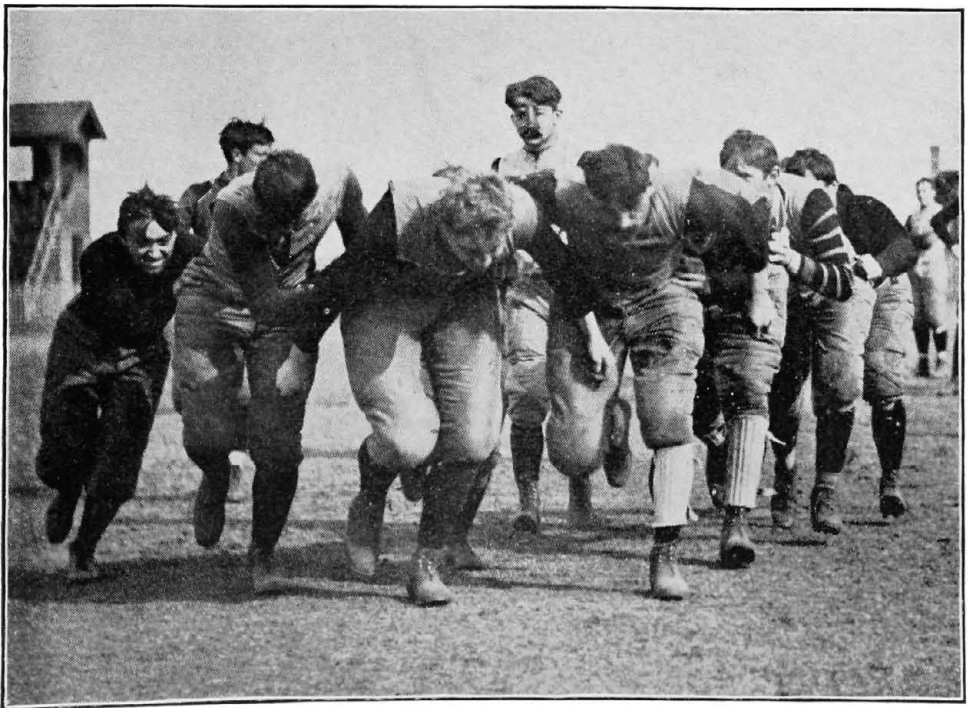
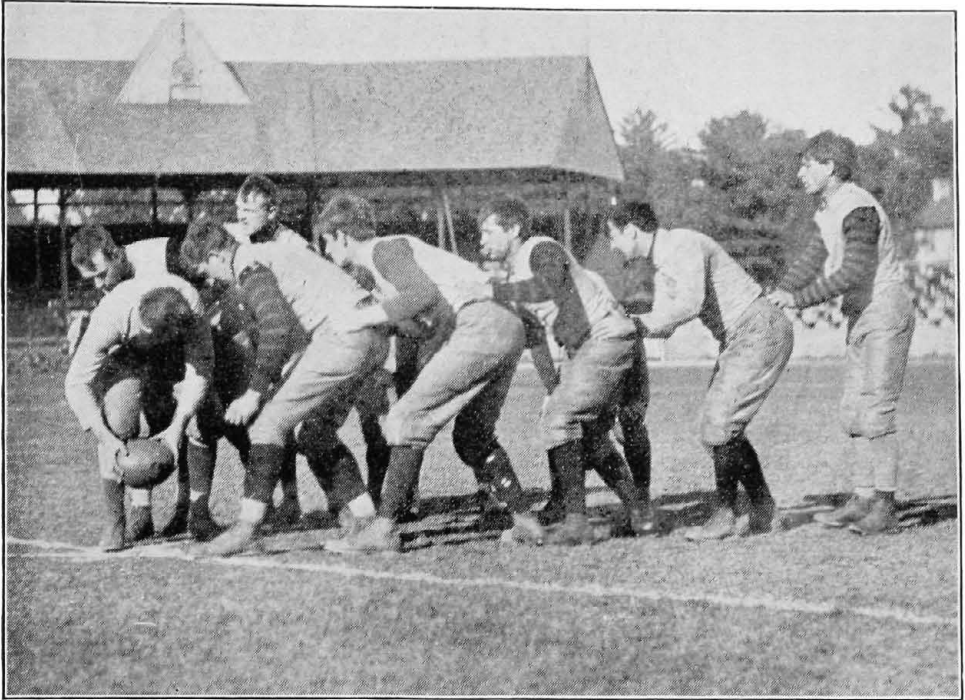

THE WEDGE FORMED AND IN MOTION



starts forward with one grand shove, protecting the runners on all sides. With this wedge, in 1888, Yale scored her only touch-

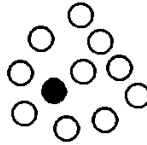

FIG. 3.

down against Harvard. Against Princeton, she would have been equally successful had not the Jersey men been afforded a week's time in which to arrange a plan of defence against the wedge. In her defence, Princeton's three centre men braced themselves, very low down, her two tackles broke in the sides of the wedge, and the end rushers played well out to avoid surprise by a flank movement.

The third form of wedge was devised in 1889 by one of the smaller colleges; namely, Franklin and Marshall. It was a simple pushing wedge, and gained its notoriety from the fact that by its use Franklin and Marshall not only defeated all the minor colleges of Pennsylvania, but also defeated Lafayette and scored sixteen points against Princeton,



which score up to that time was the largest ever made against Old Nassau by any team whatsoever. Franklin and Marshall's left guard was built like the trunk of a tree; he had been brought up in a stone quarry and a blacksmith's shop, and with his two hundred and ten pounds and stocky build, he possessed the pushing powers of an elephant. Four ordinary men in front of him could not stop his progress in a square push. With this giant as the apex, the other players arranged themselves in the order of Fig. 4.

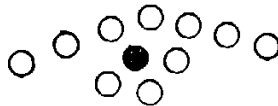

FIG. 4.

It was necessary to observe three things in the pushing wedge: first, keep the line tight; secondly, keep on your feet; thirdly, get the under hold on the opposing rushers. The pushing wedge was a concentration of energy at one point. Its one peculiar difference from other wedges was that the gains made were generally long ones. The runner, being held close in the wedge for an instant at the breaking of the opposing line, was sent

forth like a cork from a bottle, so great being the propelling force that not infrequently he lost his balance and toppled over when he had a clear field in front. If a double line were banked up in front of the apex, by the parallelogram of forces, a rotary movement was set up, and the enemy's line was broken farther from the centre. The weakness of the pushing wedge was that the entire line had to be steady at the instant the ball went into play. The University of Pennsylvania was bright enough to discover this fact, and by constantly bumping the centre men of the opposite line, destroyed the wedge. The only other way to stop the pushing wedge was to lie down in front of it.

“The Plough,” as developed by the Uni-

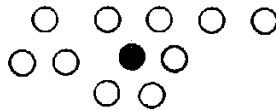

FIG. 5.

versity of Pennsylvania in the fall of 1892, was a scientific piece of wedge play. The ends of the line were drawn in, and the backs concentrated something after the style of Fig. 5.

No matter how much the opposing line was contracted, this wedge, as played by this university, made its ground. The man who carried the ball time and again rolled over the heap of centre men, and down the other side, making his distance with little trouble. This wedge enabled the University to defeat Princeton for the first time in football history, and, had not a fumble been made, the University would have scored against Yale. By the use of "The Plough," the Quaker City lads pushed Yale back for sixty yards, only to lose the ball on Yale's five-yard line by the disastrous fumble.

One of the most clever pieces of headwork in American foot-ball is the "Harvard Flying Wedge," the invention of Mr. Lorin F. Deland, of Boston, Mass. The best explanation of this wedge can be given in Mr. Deland's own words:—

"The play contains really only one new principle, namely, that of momentum; but in the application of this principle various strategic features were introduced, and in the working out of the final play some additional incidents were added with a view to confusing the opponents. The principle of

momentum enables any eleven to effect a concentration of its entire strength at any given point along the line of its opponents. It is impossible for the opponents to locate the exact point of attack, and they, therefore, not unexpectedly, retain their regular formation, with which they meet the straight wedge. If the momentum is directed against the opponents' flank, it keeps out of the defence the heavy men in the opposing centre, and the solid mass being directed at the tackle, has the advantage of meeting a man who has not been accustomed to stopping wedges. If the attack is directed at the centre, important changes are necessary in the plan.

“The strategic features which were introduced to confuse the opponents were the elements of different speeds and different times of starting, with a grouping which gave the opponents various things to notice at once. The No. 1 wedge (Fig. A), which was composed of the four heaviest men, formed on the side lines at a distance from the centre which made an exact line from their position to a point midway between tackle and end on the other side of the opponents' line, and yet left their foe to pass

in front of the ball without jeopardizing the safety of the pass. I think their position was about five yards from the side line on their own forty-yard line. This gave them a

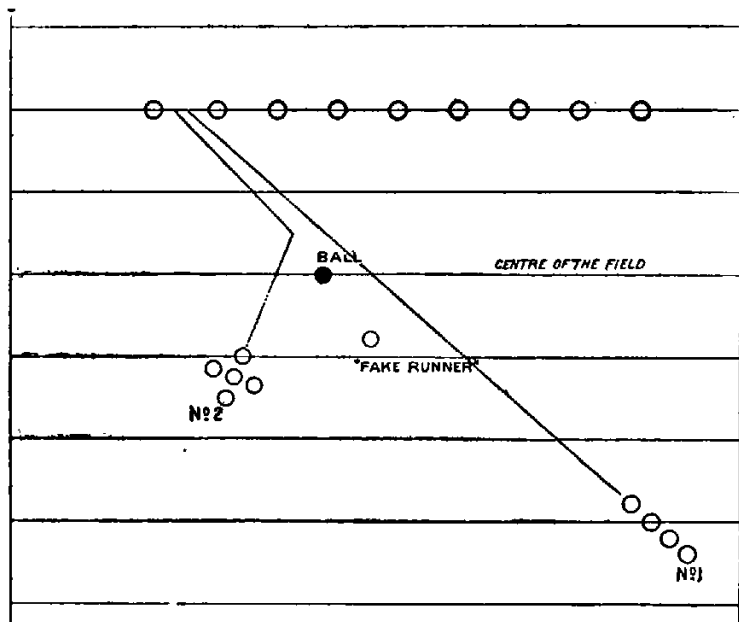

FIG. A. — Flying Wedge.

straight line, just clearing the ball, and bringing them against the opponents' right tackle (calculating nine men stretched across on the opponents' line, the tackle next to end).

“The No. 2 wedge (Fig. A) was shaped in the form of a diamond with one man in

the centre. It was located at right angles to the line of No. 1 wedge, and one-third the distance from the ball. The right angle of the line brought it into the path of the other wedge, well in advance of the spot where the ball lay, so that their movement should not jeopardize the pass. The quarterback stood by the ball in the centre of the field, and a man whom I call a "fake-runner," and who was one of the half-backs, stood at a point to the right and rear of the quarterback, and ran on a line parallel with the path of No. 1 wedge, and removed from it just a sufficient distance to bring him in as a tailman in the No. 2 wedge, when the latter obliqued and joined the No. 1 wedge. The No. 1 wedge started first and had the right of way; that is, the No. 2 wedge were to guide their speed and distance by the No. 1 wedge. No. 2 wedge started second, ran much more slowly and only one-third of the distance. The "fake-runner" started third, after the two wedges were in motion, and he ran at almost top speed. The ball was the last thing moved. That was lifted at the point of time determined by the speed of the No. 1 wedge; an instant before the first man in the No. 1

wedge reached the line, the ball was lifted. The momentum of their rush carried them across the part of the ball, and virtually covered the right of the pass, which was almost a hand-pass (not over two feet), and was made straight to the right-hand man in the diamond. The two wedges united, and the "fake-runner" came in on the outside. His swerving slightly to the left gave the appearance of his having the ball, as this movement was made just as the pass took place.

"The instructions to the combined wedges were to keep the lines closed up until the line had been passed, and an opening was then to be made on each side of the two men in the

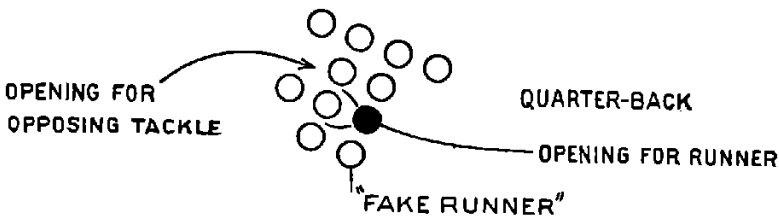

FIG. B. — "Flying Wedge" in motion.

centre of No. 2 wedge, giving the runner his chance of either one of these openings for his course down the field (Fig. B), as in this case we had selected the fastest man to take the

ball, and such a large interference would inevitably slow him down.

“The failure of the play to gain any more distance in the Yale game was due to the fact that it had been rehearsed only two or three days before the game, and sufficient time had not been given to it for its effective work. The interference did not open out, and the runner was almost brought to a standstill when the wedge met the direct defence. The right tackle was, of course, the most dangerous man, and to provide for him an opening was purposely left at the place where the two wedges joined. The quarter-back had lifted the ball just behind that opening, with the appearance of still having the ball in his hands, and the opposing tackle was thus drawn into that opening, while the real runner with the ball was well to the left of it. The instant this tackle had gone through the hole, the other opening should have been made, and it was here that the play failed of complete success.”

There are two other methods of attack which should be mentioned in connection with wedge play. First, when the ball is put into play from a down, using a line player as



the apex of wedge into which the half-back is to run. The wedge takes the form of Fig. 6.

This play was generally made on one of the tackles, and the two backs who did not

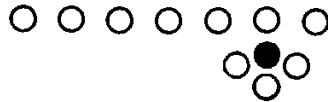

FIG. 6.

have the ball formed the sides of the wedge. In the days when rushers used arm-interference in blocking, this style of wedge could be successfully played. Since the rule against arm-interference was passed, an opening in the line gains more ground than a wedge on the tackle.

The second minor form to which we refer was designated by some teams as the "U trick." In this play, the end rusher ran in

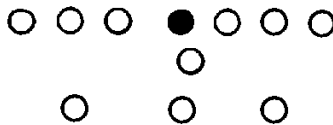

FIG. 7.

and helped to block the tackle, putting the latter into a pocket. The half-back of the side in possession of the ball drew nearer to

the line; when the ball was snapped, he rushed out and interfered with the end rusher, who, up to this time, was unguarded. Before the ball was snapped, the arrangement of the men was as in Fig. 7. When the ball was put into play, the trick assumed the position of Fig. 8.

The U-trick is retained, in modified form, in the present system of interference play.

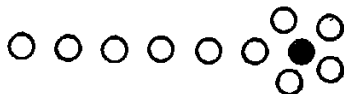

FIG. 8.

With the introduction of the wedge, much of the picturesqueness of foot-ball passed away. Many a regret is heard because the days of long passes, open play, free running, and repeated kicking are gone. The wedge contracts the play; it huddles the players; it removes the brilliancy and effect of individual effort; it injures too many players, a dozen ankles and knees being sprained to-day to one ten years ago. These disadvantages have called forth much adverse criticism relative to the wedge. Probably the most impartial and pertinent statement of the case yet writ-

ten is that which appeared in *Harper's Weekly*, of Jan. 21, 1893, over the signature of Walter C. Camp. Mr. Camp is known, by reputation at least, to every lover of foot-ball in America. He has been justly styled the "Father of American Foot-ball." To his coaching and head-work, Yale owes her prestige in this sport. Mr. Camp has done more for foot-ball in America than any other one man. By players of foot-ball, wherever found, Mr. Camp's judgment is considered supreme. Bearing in mind this deference to his opinion, we take the liberty of closing this chapter by quoting from his article, "A Plea for the Wedge in Foot-ball." Speaking of modifications in wedge play, Mr. Camp says:—

"Some have suggested that the problem might be solved by a ruling forbidding the men to hold on to one another in the wedge formation. But, here again, it would be practically impossible for the umpire to decide, because the men in most plays are so quickly in the midst of the opposing players, that the law would prove a dead letter as far as strict ruling was concerned, and only render the umpire's lot a still more miserable one.

“A suggestion has been made that the wedge be permitted only inside the twenty-five-yard lines or only outside of the twenty-five-yard lines, thus limiting the use of it and making the play more open. The objection to this suggestion lies in the fact that it is a hard matter to define exactly what the wedge is.

“But there is one objection to any legislation of this nature, and it is an objection in sustaining which I know that I may count upon the support of every devoted lover of the game. It is this: that legislation ought not to usurp the captain's rights in designating what plays he is to use so far as the placing of his men is concerned. We should give him all the chance we can for the exercise of his judgment in this respect, for it is one of the chief charms of the game. It is the result that we should ask of him rather than the means.

“The plan I would propose has the merit of following close upon the heels and after the fashion of a rule which has done more to make the game satisfactory to American colleges than all the rest of the legislation combined. I refer to the five-yard rule.

“As we now provide against the block game (which was to the spectator of the nature of the present wedge) by saying that in three consecutive attempts the ball must be advanced five or taken back twenty yards, so we can, by following a similar line, provide, I believe, for the lessening of the wedge plays, and the introduction of very many pleasing long passes and combination plays. The rule might be combined with the five-yard rule, and provide that in perhaps two downs or fairs, if the ball be not advanced ten yards, it must traverse a space of twenty yards across the field either in the hands of a player or not. When a gentleman in San Francisco first mentioned a similar proposition to me, I was inclined to hesitate about advocating it, but the more I have turned it over in my mind, the more feasible it seems. In the first place, it will materially lessen one of the ‘grown-too-great’ features of our present style of play. Possession of the ball has become abnormally desirable. It has been demonstrated that a strong team, even against skilled opponents, can carry the ball from kick-off to touch-down without giving the opponents an opportunity of exhibiting any

offence, and to be scored upon before having a chance at the ball discourages any team too much at the outset. Possession of the ball ought to be valuable, but not to such an extent; and the rule above suggested would insure the more frequent exchange of possession. Then, again, it would probably stimulate kicking, and especially long passes toward the ends as well as end-running, and these were the features which please not only the ordinary spectator, but every foot-ball player who watches the games.

“ Finally, and best of all, such a legislation avoids any arbitrary assumption that the wedge is bad or unskilful or dependent upon brute force, avoids placing the umpire in a position which no man could possibly fill with any satisfaction to himself, permits the captain to select his own method of play, and provides only in the results that he must accomplish.

“ The wedge play will continue to be used, but to a more limited extent, and with a probably greater distance of movement before meeting the line. The wedge play is not a mere weight play. It is a play that when well designed and skilfully executed has

behind it weeks of planning and study. The wedge has a right to stay and ought to be given a chance. But the wedge has a way of tying up the play to a too limited space; it has a way of exhausting and using up men who face it too many times in succession. Those outside the lines can seldom see its plan of action; they can see only the mass, and it loses its interest when worked too often. It ought to be a possible play, but not all the play, and legislation which will induce the captain for the interest of his team to use other plays as well, is the legislation that will be productive of the best results in the end."





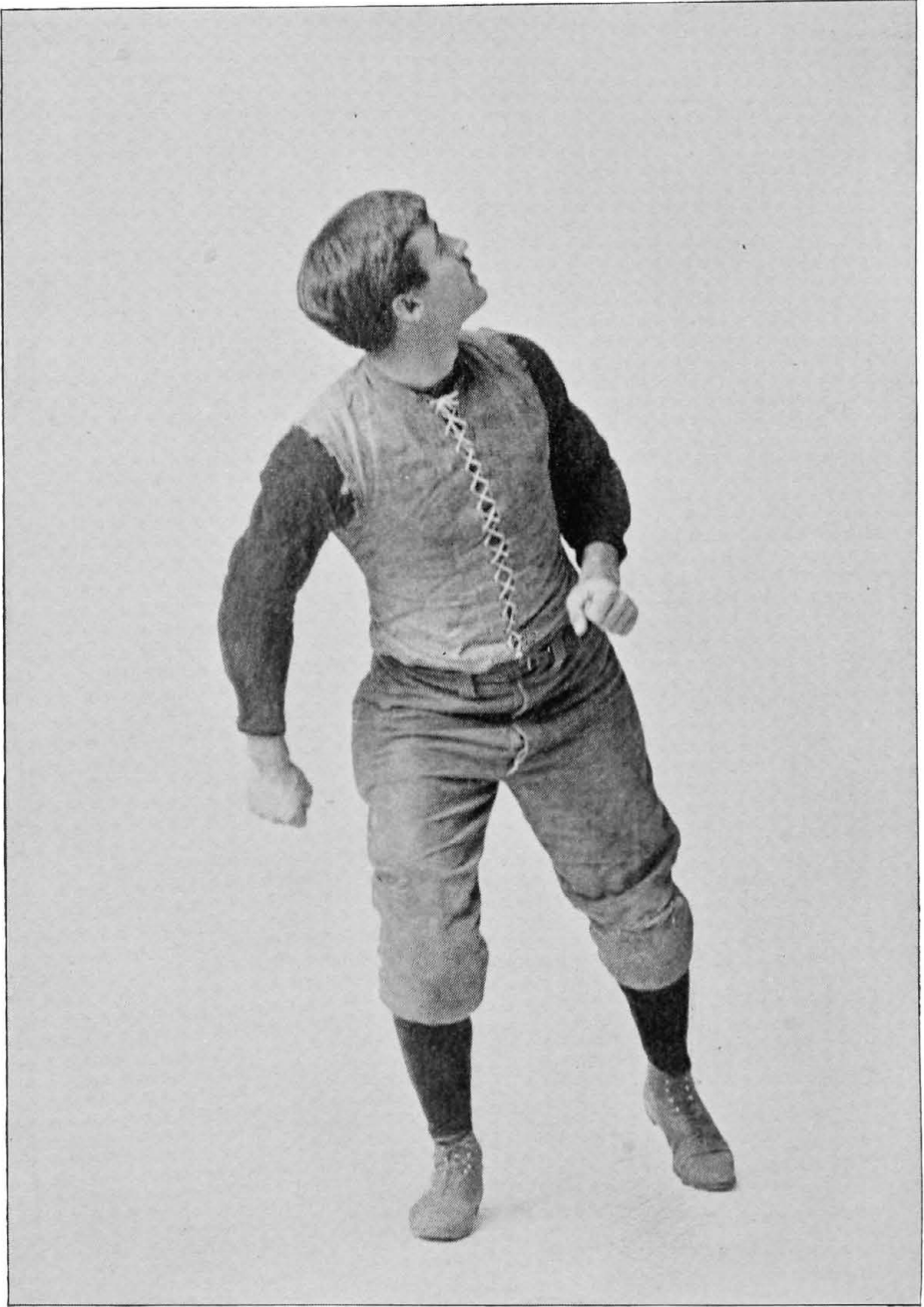

*Lo Hallam*

## THE END-RUSHER

BY F. W. HALLOWELL

END-RUSH and its style of play differs from the other line positions. The three centre men must all be large and very strong, and a tackle to fulfil the duties now imposed on him must also have great strength. An intelligent man who is powerful enough and moderately active can be taught to play a good game in any of these positions. At end it is different. There are many men who weigh from 145 to 165 pounds, who are active and fast runners, yet as end-rushers they are not a success; this is because they have not the special mental qualities required.

The ideal end-rusher is strong, very quick, and is a fast runner, but he has in addition the quality of perfect self-possession and of knowing what is happening every second of the time. He is able to judge quickly which of many things he ought to do, and then he does this without losing track of what every-

one else is doing. He has the faculty of being just where he is wanted and of being in every play. When it is said that an end "follows the ball" well, it is meant that he has this art of being in the right place at the right time.

The play of the place is divided into two kinds which differ more or less one from the other: first, offensive, when his own side has the ball; and second, defensive, when his opponents have the ball, and he is defending his own goal.

In offensive work he is generally dropped back from his position in the line and used as an extra half-back, standing a little outside and a little nearer the rush line than the other three backs. If the play is towards his side of the line, he is used as an interferer; if on the other side, he lends his weight to help on the play there, but to be effective in either of these ways he must start quickly. This starting quickly is rendered very difficult, because in order not to indicate the direction of the play he stands in the same starting position, whether he intends to run to the right or left. A common fault with green ends is to "give away" the point of

the opponents' line that is to be attacked by looking towards the place where it is going. The experienced rusher takes a general look to see how his opponents are placed, then keeps his eye on the ball ready to start the second it moves. When he has knocked one man out of the play he takes the next, and then follows down the field to get into the play again before it stops. When the signal is given for his full-back to kick, the end-rush moves out a little, even with the rush line. As the ball is snapped, he sprints for about fifteen yards, then without slacking speed looks over his shoulder to see where the ball is going, although to a forward who has been trained up to it, the movements of his opposing backs will serve as a clear index of the direction of the kick. In this running down on a kick in particular the present lack of some systematic understanding between the full-back and the line militates against the full success of the play; if there were some system of signals by which the end-rushers could learn the direction of a kick at the time that a kick signal was given, much wide running could be saved, and their efforts concentrated more closely on their duties; namely,

to see that the receiving-back does not gain ground by a run.

He always keeps a little outside the opposing full-back, but near enough to interfere with him, rather than miss him; (see Plate VIII.) for an allowed fair catch is less costly than a run of fifteen or twenty yards. He generally has it arranged with the other end-rush of his own side which one is to take the man, and which one the ball. If the full-back muffs, the quicker man goes for the ball, and the other man blocks off the full-back; but above all, on a kick, especially, the end-rush keeps track of the ball and follows it closely. Here is his great chance in the game: he brings his best points into play, — speed, agility, and quick judgment, — and if he does what he ought, and the opposing full-back makes a muff, he usually scores a touch-down.

In defensive play his chief work is breaking up interference. In the game as it was played a few years ago, he had to break through his opposing end-rush, and then everything was easy; merely tackle the man with the ball. Now it is very different; no one stands directly in front of him, but he must break up a

PLATE IV.

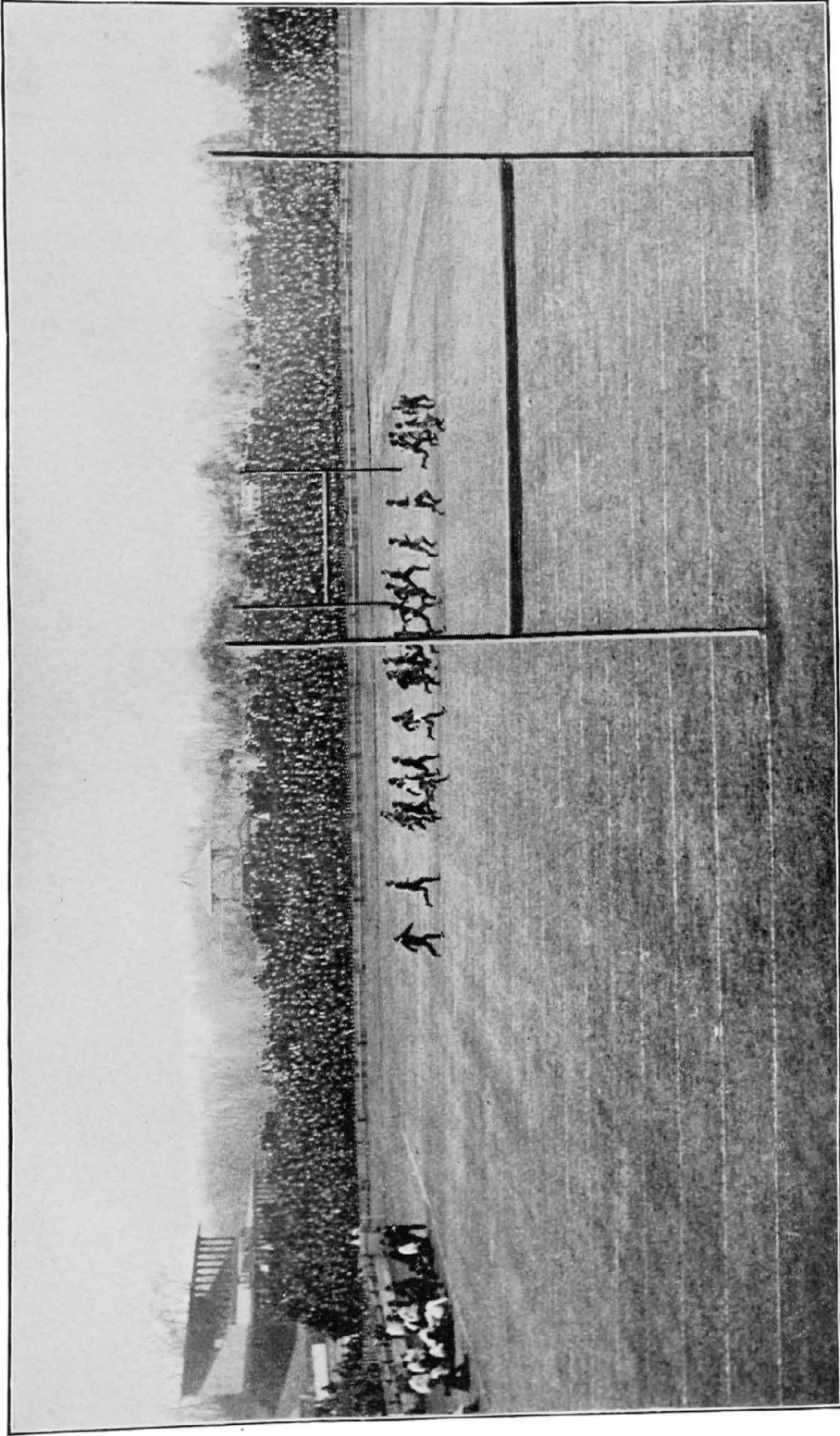

A RUN AROUND THE END

Here the half back having almost if not quite cleared the end the rusher has been careless in guarding that ground



crowd of four or five interferers before he can tackle the man with the ball. While doing this he bears in mind the fact that he is responsible for all the ground outside his position. Generally he does not get near the runner, but stops the interference and drives the runner inside for the tackle to get.

Breaking up interference is a knack, and each man has his pet way. The safest probably is to meet it squarely, always keeping at arm's length and far enough outside to prevent being cornered and pushed in. Never dash in for the runner until you are sure that he cannot dodge behind some interferer and go outside. The danger of this way is in being shoved so far out that the runner can go inside without the tackle's getting him; however, it is the end's duty to guard the outside ground first, and then take the ground between himself and tackle if he can. This guarding the ground outside first, and then dashing in if possible, is the first and most important thing to be learned in end-rush playing (see Plate IV.).

When he thinks his opponents are going to kick, he drops back five or six yards, and after waiting to be sure that it is not a pre-



tended kick and an around the end play, follows down after his opposing end and bunts him over as he slows up to tackle the full-back.

An end-rush is the privateer of the team; his work is all fast, hard, and rough, and to be able to keep in the game he must be in the pink of physical condition. It is well to train the end off the field as well as on, for there is much of the individual work connected with the place which rests simply with the player himself. If slow in starting, a good plan is to give him some lessons in sprint running, the one hundred yards probably being the best distance: he should be trained in advance of the rest of the team and kept in trim, for nothing makes a team slower than a tired end.



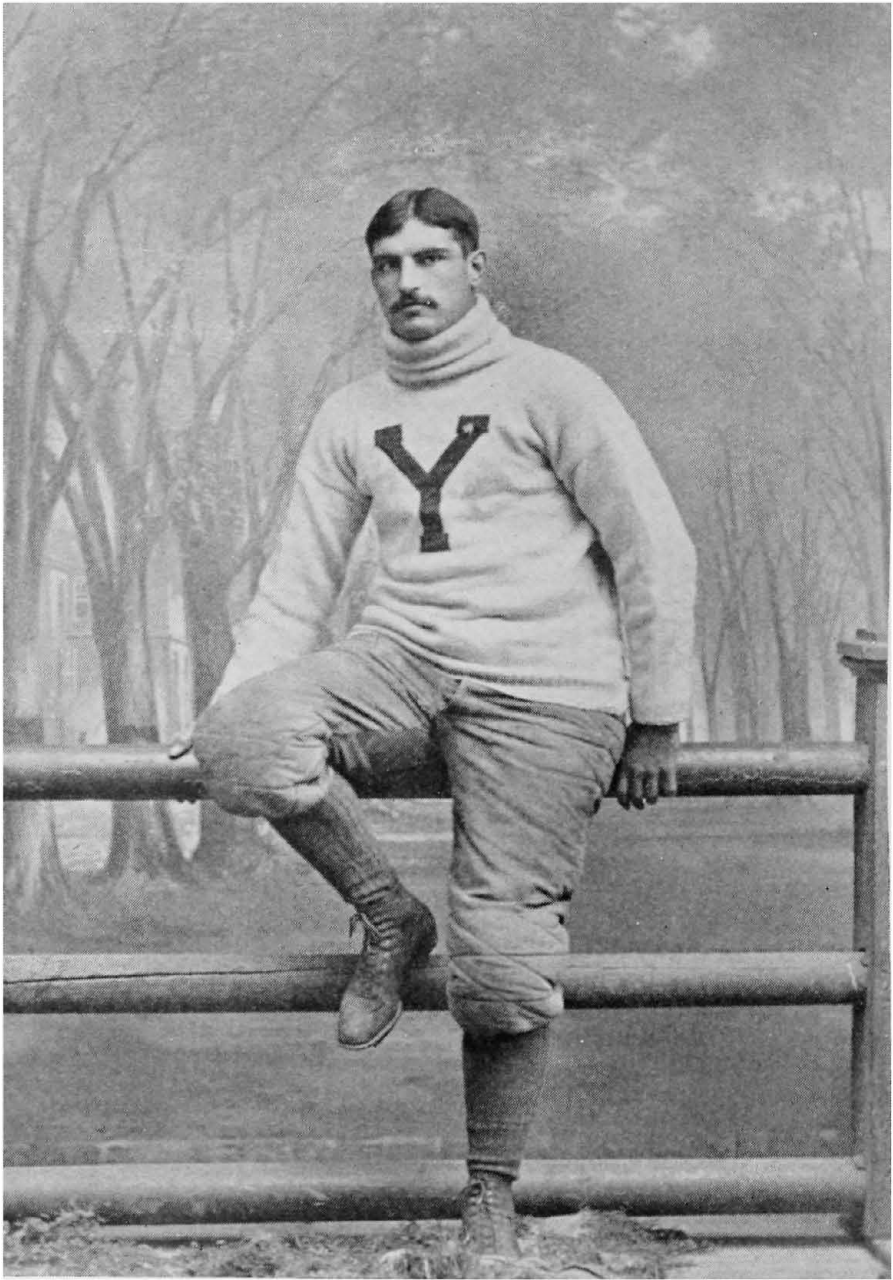

Charles C. Winter

## THE TACKLE

BY WALLACE C. WINTER

It is difficult, indeed almost impossible, to give a precise rule whereby a foot-ball player may be governed under a particular condition of play. In no position on a foot-ball team is this fact more clearly demonstrated than in that of the tackle. Upon him and the end are directed the vast majority of attack of an opposing team, thus making his duties as well as his opportunities varied and uncertain in the extreme. It is due to this fact, more than any other, that the position of tackle has of late years been regarded as one of the most important places in the line.

The position of tackle on a college team of average weight does not require a very heavy man. Rather a quick tackle of 170 to 180 pounds, than one in whom agility is sacrificed to beef. However, the main quality necessary in a tackle, other than those required of any foot-ball player, is that of adapting him-

self to the style of play. This refers not to his *vis-à-vis* alone, but to the entire opposing team. Seldom or never does it happen that two teams play the same style of game, and it is even more rare that the tackle will find himself opposite a man whose play resembles that of some former adversary.

As has been said, while no iron-clad rule can be given for any particular occasion or style, none the less are there certain general lines which should be followed out, to insure the best results both as regards the team and the individual.

To a foot-ball team, and hence to the tackle, are presented at different times the two general phases of the game. (1) When on the defensive and (2) when on the offensive. Suppose him to be on the defensive; plainly there are but three general ways whereby the ball can be advanced: (1) around the ends, (2) bucking the line, (3) punt or drop-kick. For these exigencies the tackle must be prepared; the ball, to be advanced, has got to go in one of these ways, though the manner of execution may be greatly diversified.

When on the defensive I think it safe for the tackle to always go through; this rule,

while it may not invariably be to advantage, will, in the vast majority of cases, prove so. Once through, if the ball is taken around *his* end, he must guard against being blocked off by one of the backs or "drawn in." One of the most difficult things to prevent in a new tackle is his eagerness to get the man with the ball, thus being drawn in towards the centre, where he is easily blocked off, the runner with the ball passing safely out of his reach. The tackle must in this case rely upon his end to turn the runner in. It is practically impossible to get around a good end, and the tackle may be sure that sooner or later the runner will be forced to turn; *then* is the time he must tackle him; never stop until the ball is down. It often happens when a runner has a clear field before him he may be tackled from behind. "Follow the ball!" This rule is without exception.

It should be borne in mind that the manner of "breaking through" must often be changed. A good tackle is seldom to be tricked twice in the same way; hence a change of tactics is imperative. One way of doing this is to "play low" — the instant the ball is put in play to jump into the man

opposite, thus disconcerting him and putting him off his balance. Another way is to put the shoulder under the arm of your adversary, lifting up quickly. This is especially practicable in the event of a disparity in the size of the two men. There is also the method known as "revolving," which consists of a rapid turn of the body with the arms bent and extended. The chief feature of this, however, is the very slight attention given to the elbows, or the places they may strike; except in extreme cases it is hardly to be resorted to. If the tackle be a quick man, a feint to go one side and a sudden turn to the other often sees him through. In connection with this point, the tackle should be fully alive to the importance of watching the ball *all* the time, the instant it is put in play executing the manœuvre he has decided upon; the man who starts *first* has the advantage.

When the opponents are "bucking the line," the tackle has his severest trials; the least he can do is to stand his ground; and to do really good work he should get the runner before he strikes the line. If a heavy man be bucking the line, even though the tackle does stand immovable and tackles ever so cleanly,

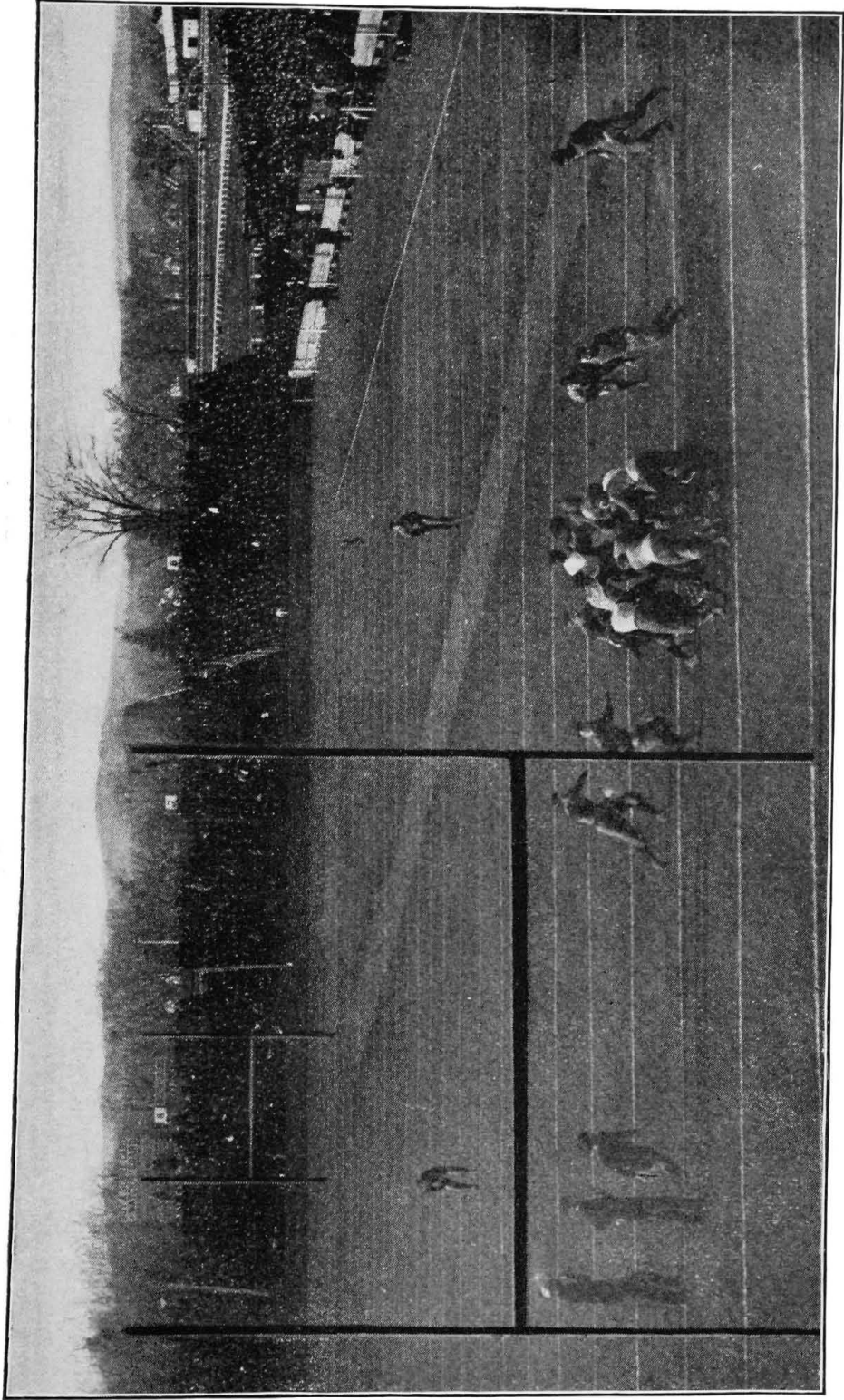

A WEDGE ON TACKLE

A good chance for the opposing tackle to break the interference by being down in front of it





it is almost a surety that the runner will at least make his length. In case the tackle finds it impossible to get through, let him push his man back and lie down before the attack, keeping a sharp lookout for stray legs and arms (see Plate V.).

When the opponents are thus directing their forces against the line, the tackle may in a measure rely upon the guard to do a great deal, especially when the attack is directed between himself and the guard. However, when made nearer the end, he has more to do than ever. He must do all the tackling possible, thus saving his "line-back," presumably a lighter man, and one not calculated to withstand the onslaught of a heavy runner alone.

In the event of the opponents resorting to a punt or drop-kick, the same rule of "going through" applies. The tackle must himself do so, or else make an opening through which an extra man in his line can pass. Nor does his work end there; he should follow the quarter-back or "line-back," since it is altogether probable that his predecessor has encountered one or more of the opposing blockers. In addition to this, he should care-

fully guard against the successful execution of a "bluff-kick"; for his end having run down the field, he alone must guard that point; to prevent this he should keep on the *outside* of the kicker, thus preventing the circling of his end, and enhancing his chances for a clean tackle.

When on the offensive, the play of the tackle is necessarily changed. He must guard against the same contingencies that he practises when on the defensive. If it is intended that the ball be taken around his end, he must block his man effectually and long. It is a good rule to follow never to cease blocking until the possibility of "your man" getting the runner is past. Of course the amount of time thus required depends upon the swiftness of the runner and the character of the interference. In case the ball is taken around the other end, the blocking may be of shorter duration; in fact, it is seldom that any blocking, to speak of, by the tackle is necessary; for his energies will be better expended in following directly behind the runner with the ball, thus precluding the possibility of a tackle from behind; as well as being close to the ball in the event of a fumble.

When the "backs" are "bucking the line," the tackle has much to do. Should the signal call for a break in the line between himself and the guard, he must push his man *out*, and that quickly; if unable to do this, push him *forward*. One of the best ways to make a hole in the line is to play very low and slightly back from the line, jumping forward quickly, getting the opponent a little below the hip with the shoulder. It is seldom that an adequate opening cannot be made in this manner. Should the opposite tackle habitually play very close to his guard, instead of attempting to push him *out*, he may be pushed in, often with good results. This necessitates very rapid movements on the part of the offender, however, inasmuch as the guard is pushing in the same direction. To facilitate the success of the play, a signal may be arranged between the tackle and the back, whereby the latter may be advised in what place he may expect to find an opening.

When a drop-kick or punt is contemplated, the situation changes, if the former, the tackle on the offensive, as well as the entire team, should block *hard*, until the ball has been safely dropped. The system of blocking gen-

erally used in the event of a kick is that known as "taking the inside man"; that is, beginning with the centre, each individual man is confronted by a single individual: in case of an extra man coming up in the opponents' line the tackle must move up and confront him, while the end takes up his position in the nearest vacancy. If a punt, the tactics of the two tackles are somewhat different. If the back who is to do the punting is "right-footed," *i.e.* kicks with his right foot, the left tackle can leave his man after but a very brief detention, whereas the *right* tackle must block somewhat longer before he can feel assured that his man will not interfere with the kick, and *vice versa*. With a correct system of blocking behind the lines by the backs the tackles should feel able to "get down the field" after but a very brief delay. With an unusually quick quarter and full-back the tackle whose side the kicker does *not* favor should "get down the field" immediately, taking care, however, that the opposing man be made to go on the *outside*. This is safe, as has been said, only when there is more than average celerity behind the line. The exact length of time to block

for a punt can only be determined by constant effort and repeated trial.

The system of having the tackles run with the ball from the line is not so unusual as might be expected, considering the advance in the recognized importance of that position in late years. A few words on this phase of the tackle's career may be of assistance. If the tackle is to run with the ball, he should play in as close to his guard as is consistent, that is, so as not to advertise the proposed move to the opposing team; if he generally plays "away from his man" a little back of the line, so much the better, for he thereby gains an instant in getting started for the ball. Immediately upon the ball being snapped back, the guard should put his foot out as far as he safely can, thus offering an obstacle to the following through of the opposing tackle, while the end, cautiously edging in towards the tackle, should follow immediately behind, offering an additional hindrance to the following adversary. In running with the ball in this manner the runner should first get the ball safely in both hands; second, bending down as low as possible, go for his opening, (generally between the other guard and

tackle), head first: it is absolutely essential that the head should be well lowered. If success attends his efforts, and he is cleanly through the line, he may straighten up, and then exercise such half-back qualities as he may possess. Practice in quick starting and turning should be given off the field as well as on, for upon his quickness in "getting away" will depend in a great measure the number of yards he gains.

Concerning the tackle's duty in interference but little can be said in this paper, since it is essentially a team move, and must be treated as such in a separate paper. The tackle has his duties in interferences, as in all other moves on the field, but they are so closely allied to those of his fellow-players that any attempt at giving even a "general rule" would be unsatisfactory and useless.





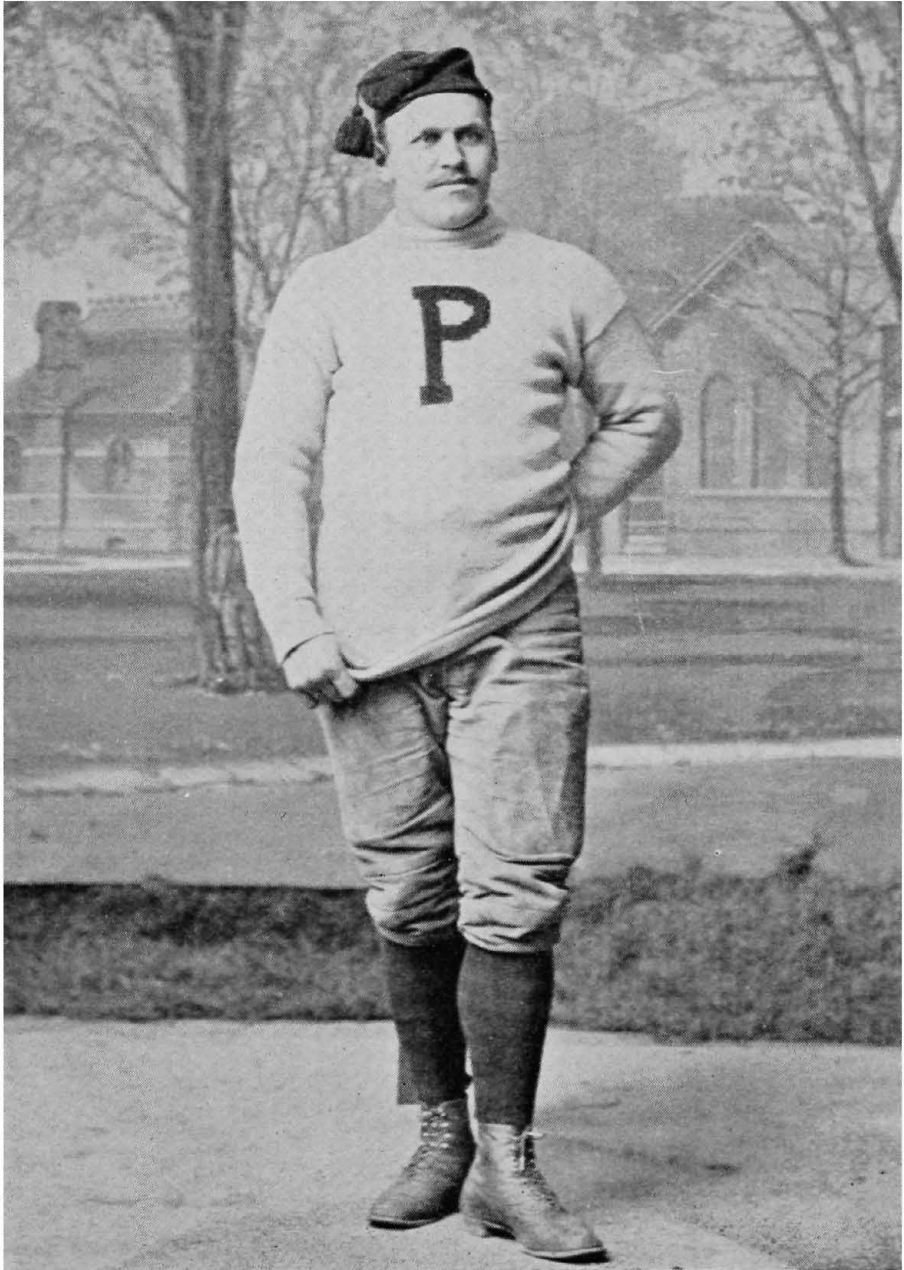

*A. W. Cowan*

## THE GUARD

BY HECTOR W. COWAN

SINCE every year brings more or less of change and advance in the game of foot-ball, and what a few years ago was regarded as most important may be superseded by something much better, I will not dwell too much upon the minutiae of the game. There are, however, certain qualities and characteristics which must be adhered to in order to become a successful player; and it will be the more elementary points, therefore, on which I will place most emphasis. First, in regard to the qualities which are necessary for a first-class guard — they are these: muscle, brain, and speed.

If a captain, in choosing a man for this position, finds one with all these qualifications, well and good; but if not, he should look first for weight. The game as it is now played needs strength at the centre of the line; and for that reason, a captain should

not be too hasty in discarding a heavy man because he is slow and awkward. Many of the most noted guards were such when they first took up the game, but by sharp coaching and hard work have made a name for themselves.

In the beginning of the season, the smaller man will almost invariably make the best showing; but the captain should have in mind, when choosing his player, which will be the better man at the end of the season. In this way, the mistake which so many captains make by constantly changing their men, and coming down to the time of the important games with an unsettled team, would be avoided.

The team should be substantially chosen in the first two or three weeks' practice; and if it should be deemed expedient to make a change later, do not waste any more time than necessary in doing so.

A rush line, to work together as a team, must understand one another; and this cannot be when the men are constantly changed. It is my theory, that a naturally inferior player who plays with the team is preferable to a star player who works independently.

It might be well for me to explain what I mean by brain: not necessarily the brightest men in the class make the best players, but those who play understandingly, have a system in their play, and make every movement count. Any one trying for a place on a team should make a study of his position, and not depend too much on a coach.

As to the duties of guard: When the opponents have the ball, you are supposed not to know what is to be done with it. The experienced player, however, can almost invariably tell, and should act accordingly. There is one point that the guard must always keep in mind, and that is to interfere with the opponents' quarter-back. He is not always to try this, but watch his opportunities. The times when it is most effectual are on a kick or third "try"; in either case, he is not to stop if he fails in this attempt, but to follow up the ball. In case of a kick, he should try and place himself before the kicker, with arms extended to intercept the ball. This is one of the duties of guard; and if he is active, he will be surprised at the number of times he is successful in either stopping the ball, or, failing in this, so to

interfere with the kicker as to shorten his kick, and be in a position to prevent his putting his men on side.

When the opponents run with the ball, his first duty is to see that no ground is made through his position, either by an opening being made or by a small wedge. The opening that he is especially responsible for is that between himself and tackle, and in breaking through the line he should generally go through on the outside of his opponent, not to stop there, but follow up the ball. He will often be able to tackle the runner from behind, or even before he reaches the line, and so cause him to lose ground. There are times, however, when it is not the duty of the guard to try to break through so much as to keep from being shoved back, and that is when small wedges are formed against him.

He must play low and, if possible, throw his opponents back before their combined weight is against him; at any rate, he should put himself in his strongest position, and hold on until his associates are able to relieve him of the strain by breaking up the wedge. The guard who can withstand this kind of play is a valuable man, even if he should not be pro-

ficient in some other plays, for the reason that the most demoralizing thing to a team is to be unable to stop these short advances.

In tackling, a guard, as well as all players, should tackle low whenever it is possible; but there are many times in the guard's position when a low tackle is impossible on account of close quarters, and he should never hesitate to tackle his man wherever he can take him. It should also be borne in mind that the guard, on account of the close quarters in which he is so often placed, has a splendid opportunity to deprive the runner of the ball, and in attacking the ball, he accomplishes either one of two things, — getting possession of it, or the runner, feeling the ball slipping from him, immediately gives up all thought of advance, and crying "down," so deprives himself of any opportunity for advance that may be offered him. For this reason the captain should impress upon his team the necessity of always trying to take away the ball.

Thus far I have tried to show some of the most important duties of a guard while the opponents have the ball; now the duties

which fall to a guard taking the offensive side. The three centre men should be as one man: they should stand close enough together to support one another. It is good policy for the captain of a green team to crowd the line pretty closely together, which may be done by the tackle and end coming in toward the guard, irrespective of where their opponents may stand. In this way the line has more stability and allows the quarter and backs to work at a better advantage.

The first duty of a guard, when his side has the ball, is to block well. He must be sure to give the quarter time to get rid of the ball. It is well for a new player to be very careful in this regard; for nothing will hinder team work more than to have the quarter interfered with by having the opponents get through too quickly. It also depends on the play as to the length of time that he should block his man. If the runner is to go through by his side, he should endeavor to force his man the other way. If a V or small wedge is formed on himself, he should force his men backward, or if there is to be a run around the end, he should let his man through, delaying him just enough to give the quarter

time to pass the ball. By so doing, it places him too far behind the runner to do any damage, while if he be blocked too long, he may notice where the runner goes and by going behind his own line be able to head him off.

If the play is to be a punt he should hold his man long enough to allow the back time to kick, and in this case it depends very much on the quickness of the kicker. If the kicker is slow, he must block the longer. Some of our great games have been lost or won by a blocked kick. If the kick is a try for goal, the guard should block his man till the ball has actually left the foot. The guard's work, however, is not done when he has blocked his man, but in case of a punted ball, he should run down the field to assist in preventing his opponent's backs from running with the ball, or, in case of a fumble, be in a fair position to obtain it. On the other hand, if the ball is played for a run toward either end, having blocked his man long enough to allow the quarter to get rid of the ball, he should immediately hasten ahead in advance of the runner and interfere with the opposing backs.



A guard should never be idle, but should throw himself into every possible play and study to see how he can make his weight count for the most, and, above all, should endeavor to play with and for the team.



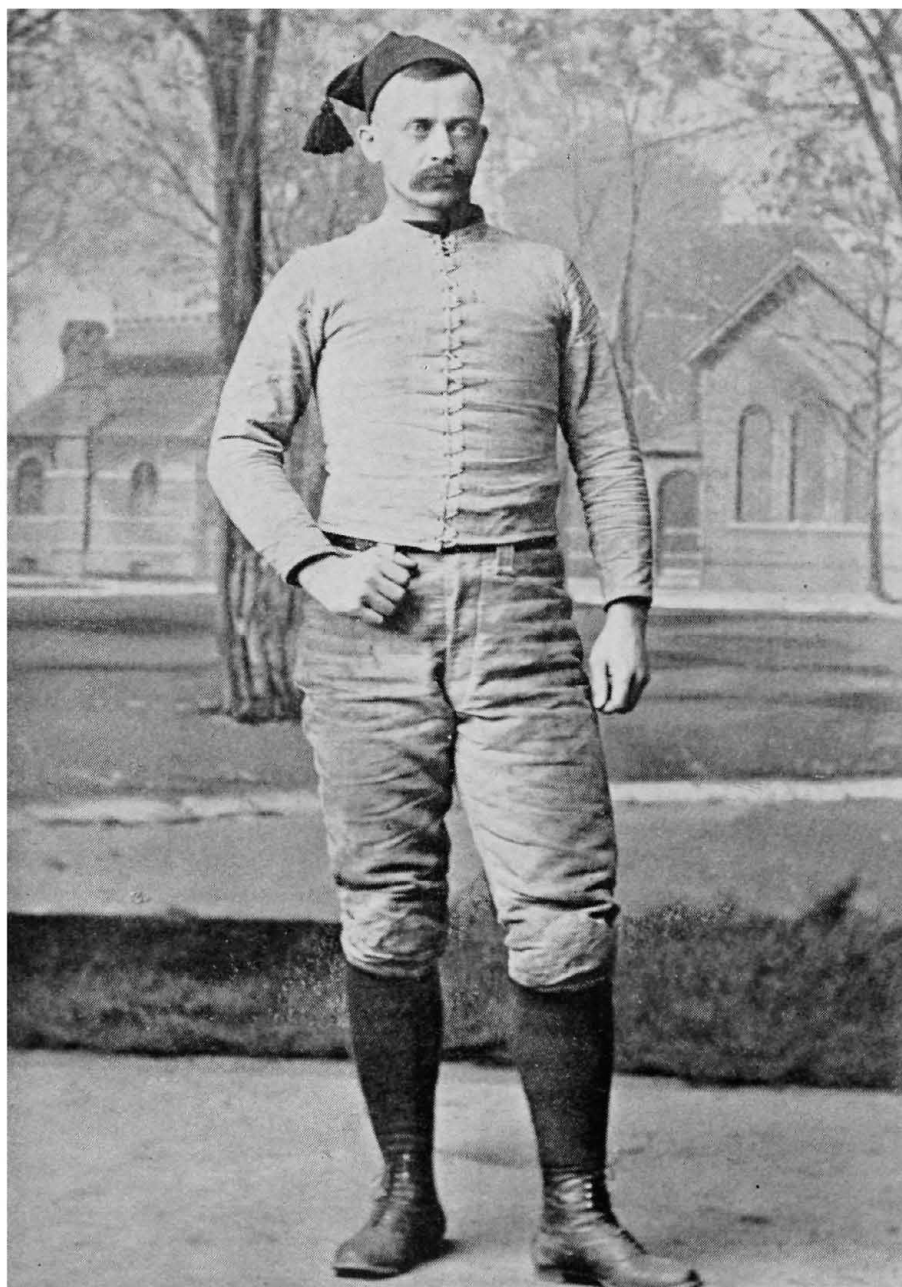

L. V. K... ..

## CENTRE-RUSH

BY W. J. GEORGE

THE centre of a rush line is the key to the beginning of all successful play. In all scrimmages the ball is put in play by the centre of the line. There is, therefore, necessitated at this point, a concentration of strength and carefulness which cannot be too closely considered by the captain of a team. Unless the ball is put in play accurately, and at the same time complete protection given to the receiving quarter-back, the intended play is unsuccessful, and the opposing side has compelled, with loss of ground, an additional down, or possibly has secured possession of the ball.

The first essential that a centre must have is strength, physical power; he must have strength enough to withstand the onslaughts of his opponent, and to be able, with some measure of certainty, when called on, to force him back, or at least to so entangle him with

one or more of his own players as to render his efforts to hinder the play in operation futile. This must be accomplished under the disadvantage of sending back the ball to his quarter-back carefully and accurately, while the other centre, unimpeded by not having his attention divided between the ball and his opposing player, is marshalling all of his strength and ingenuity to circumvent both objects of his opponent. He will not only be called upon to withstand the individual efforts of the player opposite him, but more than any man in the line, will he be made the objective point of attack by the united efforts of the entire opposing team.

Most of the heavy wedge work is done in and around the centre of the line, so that the centre man, if not always the apex, is in every wedge-play, and receives the brunt of the force from the opposing side.

The centre must also be a man of perfect self-control. No player on the team is more severely tried than he; no position offers more temptation to a naturally unruly temper. Stooping low, and when his own side has possession of the ball, his entire attention seemingly given up to it; unobservant of the

schemes of his opponents in front of him, he is pushed and shoved about in a way that would be calculated to try the patience of the man of Uz. His most exasperating annoyances come quite as frequently from the opposite guards, as from the centre himself. Just when he gets nicely balanced and when he has secured an advantage over his man, and is fully prepared to snap the ball, he receives a shove from one of the guards which completely knocks him off his balance, and renders him powerless to put the ball in play until he has again reinstated himself in position. He is also subject to rough treatment, not intended for him, it is true, but nevertheless annoying; this may come from his own guards in their struggle with the men opposite them, or from runners going through the line near centre, or from those aiding them, as in the tandem play.

The position necessitating him to play low, and well bent over, when he has the ball, renders him an almost entirely defensive player, in that his eyes are diverted from the man opposite him to the ball; and yet he is offensive in that he has the advantage of knowing, previous to his antagonist, the moment at

which the ball is to be put in play. The constant surging of the line is pinned against him, and he has not a moment's peace from the time that the game is called until it closes. For this reason he must be a man of wonderful self-control, a man who, under the most exasperating temptations to yield to anger, can be relied on to hold his entire being subservient to the accomplishment of the projected play. No man is fit for the position, no matter how strong he may be, unless he has complete control of his temper. The times when he will be most severely tried are always the most critical, and a moment's rash act may entirely destroy the chances of victory.

The true centre must also be a man of the most exacting carefulness, — a carefulness divested of slowness and deliberation, but retaining all of the elements of prudence. Unless the ball be delivered properly to the quarterback, there is necessitated a break or halt in the play, the result of which may be most disastrous. Every play, that it may be carried to a successful termination, must receive proper support at every point in its progress. The nearer the beginning of the play this support is wanting, the more complete will be

its failure. A down may seem a trivial affair, yet it is a tremendous waste of energy when brought about by carelessness, as well as most demoralizing to a team. The most important consequence is, however, that every play gives to the opponents a chance to secure possession of the ball.

Strength, self-control, and a painstaking carefulness are the three qualities that every centre must have as a foundation on which to build up his system of play. These three qualities are simply the initial ones. The "star" centre is the man who, in addition to the triad, has the ability to outwit his opponent, and the quickness to foresee and forestall his schemes.

To deceive your opponent, and to do it in such a way that you lead him to believe that he is getting the best of you, is indeed a rare gift, but one which no man stands in need of more than he who accepts the position of snap-back on a rush line.

Under no circumstances should an opposing centre be allowed to interfere with the safe delivery of the ball into the quarter-back's hands. It is true that an umpire can control this largely, but a finished player will have



all of the resources at his command which will enable him to carry out his duty in the event of the umpire being either inattentive or unmindful of centre interference. To get the ball back successfully, he must be firmly balanced, so that a slight shove or pull from the side will not affect the direction of the force applied to the ball.

It is not necessary that he should exhaust all of his strength by concentrating his powers against his opponent during each individual time that he sends back the ball. Indeed, it is of the utmost importance that he learn how to husband his strength so that it may serve him in good stead at the proper time.

In interference the centre has, of course, the duties of the other forwards, although the close play at this point necessarily makes his work in this direction more limited than that of the outside line. As a general rule, he should strive to keep himself between the runner and the opposing centre, so as to interfere in case of an attempt to tackle. He should endeavor to cut off his opponent to the opposite side from that to which the ball is to be advanced. For instance, if the run is to be around the right end, he should cut off his

opponent to the left, he himself being between him and the ball, to see that he does not in any way mar the play.

In the case of a kick by his own side the opposite centre must always be blocked for a sufficient length of time to allow the full-back to get in his kick, and no longer. Just the proper time to hold the opposite man is a hard thing to lay down by rule, since the personal equation enters so largely into the calculation; some quarters are quicker in their movements than others, and the time needed by the full-back will vary in proportion to his skill in kicking; it is an interval that must be learned anew with each new combination of players, and the only way to do so is by experiment in practice games. The green player is apt to hold his man too long, and thus ruin his own chances of getting down the field in time to be of any assistance, while to the veteran the temptation is great to allow the opposite centre the right of way too soon, in order that his own pathway down the field may be unobstructed. It never ought to be possible for a centre to block a kick unless the play has been delayed by either the quarter or kicking-back.

The primal duty of the centre is, of course, in putting the ball in play, although up to 1885 the end generally assumed this function when the ball went into touch: it was seen, however, that this could be with profit left to the hands of the snap-back, since, in constantly handling the ball, he had an advantage over the vicarious practice of the end. Peters, of Yale, was the first centre to assume this part of the play, and his thorough mastery of the art at once demonstrated the soundness of the innovation.

In the earlier days the ball was laid on its side and rolled, or snapped back by the foot, the centre standing nearly upright to combat the onslaught of the opposite man: it was found before long that the ball could be gotten back more accurately, and with greater advantage to the quarter-back, if placed with the long diameter up, still being sent back by the foot; then it was found that this did not give a man opportunity to play low enough to withstand a charge from beneath, and the hand was substituted for the foot, insuring a greater measure of accuracy, and allowing lower play (see Plate VI.).

The two most apparent weaknesses of a

PLATE VI.

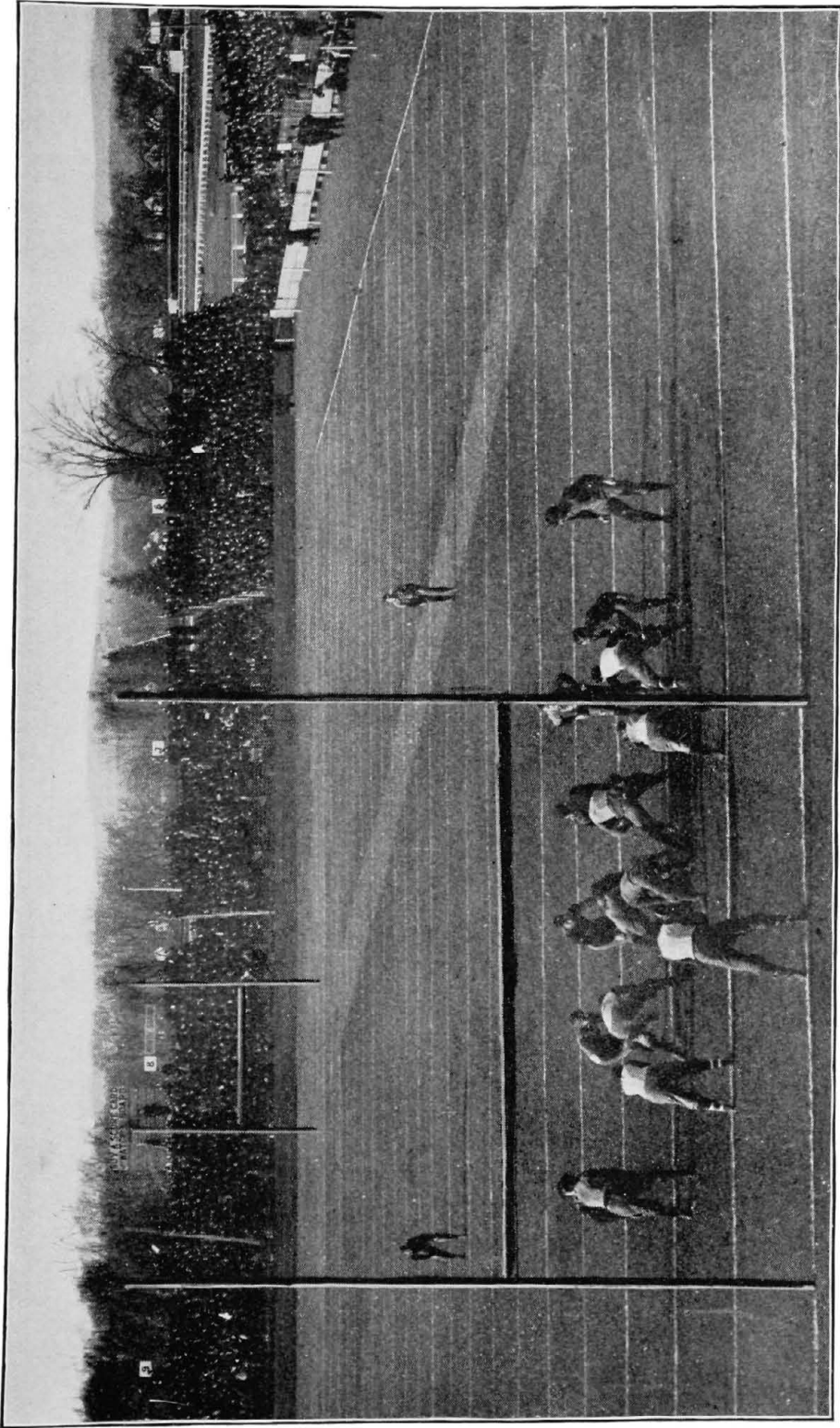

CENTRE

PUTTING THE BALL IN PLAY

Showing the positions of centre and quarter back; the play to be a kick by the full back as indicated by the position of the backs on both sides



beginning centre, in regard to play relating to the ball, are his inability to stand so as to prevent his opponent from pushing him over on the quarter, or in endeavoring to remedy this fault, so bracing himself as to have one leg and foot in line with the delivery of the ball. These are faults to be overcome by practice, but there are two recognized ways of standing, each with its advantages and disadvantages. The most generally adopted is that with the legs square, neither withdrawn much behind the other, and the body well bent over, the ball delivered just at the moment that a short charge is made against the opposing man. The advantage of this position is that there is no chance of deflecting the course of the ball with a misplaced foot or leg, and the disadvantage that it is easier to throw a man, so standing, from his balance, than it is where he uses the second position; that is, with the leg thrown back as a brace or prop. Constant practice will give a man the desired stability in the first, or square position, and it has, moreover, the advantage of not allowing as much side space for a runner coming through the line.

Another essential part of the centre's duties

is that of following the ball: since all plays originate from him, any delay on his part in lining up, not only delays the execution of a play by his own side, but affords the other team, if they be a bit slow, the opportunity of collecting their scattered forces the better to withstand an attack: therefore it should be the object of the centre to be on the spot where a down is called, as soon as, if not before, the referee's whistle announces the fact.

As has been said, most of the offensive wedge work is aimed at the centre of the line, and upon him devolves in a great measure the duty of stopping the success of the play. A wedge may be stopped in several ways: smashed, by direct weight at the apex; broken by a man thrown under the feet of the runners, or its advance turned to a lateral or even, perhaps, a retrograde movement. In any of these methods the position of centre-rush and his attribute of physical power serve a good purpose, particularly so in the last, for meeting a wedge *low* at the apex, before it has gained great momentum, he can generally check it for a moment, and that moment should suffice for a well-trained guard and his attendants to turn it on itself, by force

directed to one side of the point so that it may be "skewed" and twisted on itself, as a skilful cowboy will "mill" a herd of stampeding cattle, by driving in the leaders.

No other position on the line offers such rare opportunity for unobserved strategy and trickery, and the head plays by far a more important part than the body. From the beginning of a game until the end each man is struggling to outwit and deceive his opponent, quite as much as to withstand and overmatch his physical efforts.



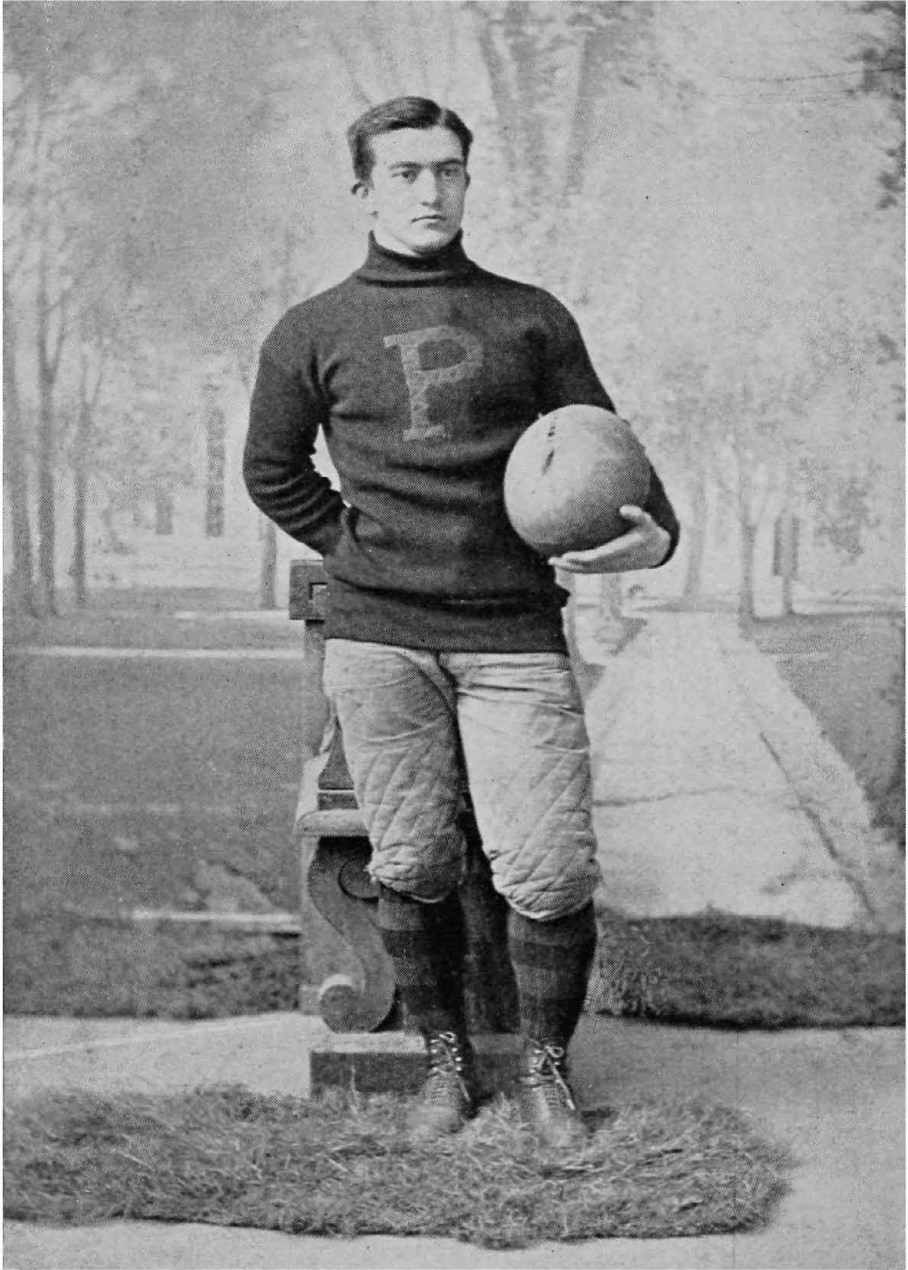

Edgar Lee Poe

## QUARTER-BACK

BY EDGAR ALLAN POE

QUARTER-BACK is now, beyond doubt, the pivotal position on a foot-ball team, the one around which everything revolves, and on which, other things being equal, the success or failure of an eleven hangs. No other position, except, perhaps, that of tackle, has made such rapid strides in importance during the last five or six years.

To appreciate this one must bear in mind, first, that it was not until 1882 that a player was specially assigned to the place; before then, any one of the backs nearest to the centre at the time, stepping in and receiving the ball; and secondly, that even after the position itself was put on a firm basis, the tasks of the incumbent were for several years few and primitive.

The average quarter-back considered that he had acquitted himself creditably, if, during a game, he made but few fumbles, was up in

his place in time, missed a tackle only occasionally, and passed the ball accurately.

But this state of things was not destined to last. 1887 marked the beginning of a great change.

The game assumed new features; and the result has been the introduction of a more elaborate system of signalling, and the concentrating of almost all of the plays around the quarter, till now his duties have become more varied and complicated than those of any other player on the field. The new system of signalling adopted, and the assigning of the duty of giving these signals to the quarter-back, has been one of the main causes of the sudden rise of the position into such prominence.

Prior to 1888 the captains themselves invariably gave the signals. During that fall, however, at Princeton, it was discovered that this task could best be performed by the quarter-back, inasmuch as he was best situated to take in the whole field and spy out the weaknesses of the adversary. Yale and Harvard stuck to the old idea until the following autumn, when all the teams recognized the wisdom of Princeton's method;

and since then, controlling the eleven on the field has become one of the acknowledged, as well as one of the most important, duties of the quarter-back.

· So essential now, to success, is skilful and rapid manœuvring of one's men that it seems to me a quarter should henceforth be chosen primarily for his ability to select his signals with judgment and to give them with rapidity.

There is no doubt but that the big games are rendered less attractive and interesting, and the strength and effectiveness of an eleven's offence are greatly weakened by the quantity of time that is consumed by the quarter-back in deciding upon his next play. This leads me to state that the growing tendency to always put the captain at quarter-back, when possible, is a mistake. His duties are numerous enough, without adding to them that of giving the signals. Besides, especially in the final games, the knowledge that whatever play he may decide on is not subject to review by any one else, and that thus the whole responsibility of it rests upon himself, often causes the captain to pause and deliberate, — a thing detrimental, as I

have just mentioned, to the game and his side.

Were the quarter not the captain, however, he would not be burdened by this feeling of ultimate responsibility, and hence would be more liable to call off the signals without hesitation; knowing that should he make an error of judgment, the captain is there to correct him.

Next to a good cool head the chief requisite for a quarter-back is agility combined with strength. In this respect both McCormick of Yale and King of Princeton were ideal men for the position. Each was like a cat in his movements and a bull in his strength, — a combination but rarely seen.

Outside of signalling, the duties of the quarter-back may be divided into two classes, — offensive and defensive.

First, as to the former. In every play the ball passes through his hands. It is essential therefore that he always be up in his place the instant the referee's whistle blows. As to how far from the centre he should stand is a matter for each one to decide for himself.

About two feet away seems the right distance. This allows the ball, when properly

snapped, to bounce but once before reaching the hands.

The hands themselves should be kept flat on the ground till the ball touches them. In passing for a kick, the preferable way is to jump back a couple of steps, assorting the ball while doing so.

Yale rather inclines toward the idea of standing still and tossing the ball back immediately.

This latter way is a little risky ; for in 1889 the quarter's hand was caught and a touch-down resulted, and once during the game with Princeton this fall, McCormick's pass was similarly intercepted and the benefit of a kick thereby lost.

In the plays around the end, the quarter should do as effective interference work as any man on the team. He should be off the moment the ball is in his hands, passing it while in motion, and should keep ahead of and close to the runner all the way down the field, knocking off first this man and then that.

As he is generally short and stocky, the work is easy and at the same time very entertaining. In fact, nothing affords greater

pleasure on the foot-ball field than bowling over some big opponent just as he is bracing himself for a tackle.

In all plays through the line he must go through in front of the runner, and aid not only in making a hole for him, but also in pulling him forward.

This, a much more difficult task than interfering around the end, though it may not appear so at first glance, requires great agility in movement and exceeding rapidity in starting.

The mode of delivering the ball to a runner varies. To a half-back or full-back it should generally be tossed. In the case of a line man, however, the better way is to hand it. The quarter must recollect also that when there is to be a kick, his work does not consist in merely passing the ball. He should ward off from the full-back any opposing rusher who may happen to break through, especially in the centre.

There are also many tricks to enable him to run with the ball, which I will not undertake to mention, since they are beyond the scope of this article.

A few words now as to the defensive work. Here he can be of invaluable service also.

Indeed, as the game is played to-day, he has as much tackling to do as any man on the eleven.

Not many years since, his duty was to simply back up the rush line and hold himself in readiness to tackle the runner in case he got through. He was used more as a safety man, and only occasionally did he resort to an aggressive policy.

But lately the defensive system of the team has been greatly improved. The two half-backs have been moved up close to the line, and they, along with the quarter now constitute as it were a second rush line.

By reason of this change the quarter has a greater freedom of action, and consequently we see him playing now as aggressively as the regular rushers. I might almost say even more aggressively; for having no fixed position, he is at liberty to break through now here, now there, though in the main he should confine his efforts to attacks on the opposing centre.

Lastly he can assist greatly in blocking a kick, either by going through himself or enabling another of his side to do so, by diverting the attention of his man.



In this general manner I have touched upon the main points of the position of quarter-back.

The opinions that I have expressed are based upon actual experience in the position and a close observation and careful study of the methods employed by others.

Of course every good player should have a style peculiarly his own, but if in developing it, he remembers the few fundamental principles that I have endeavored to lay down, I think he will find them of use.



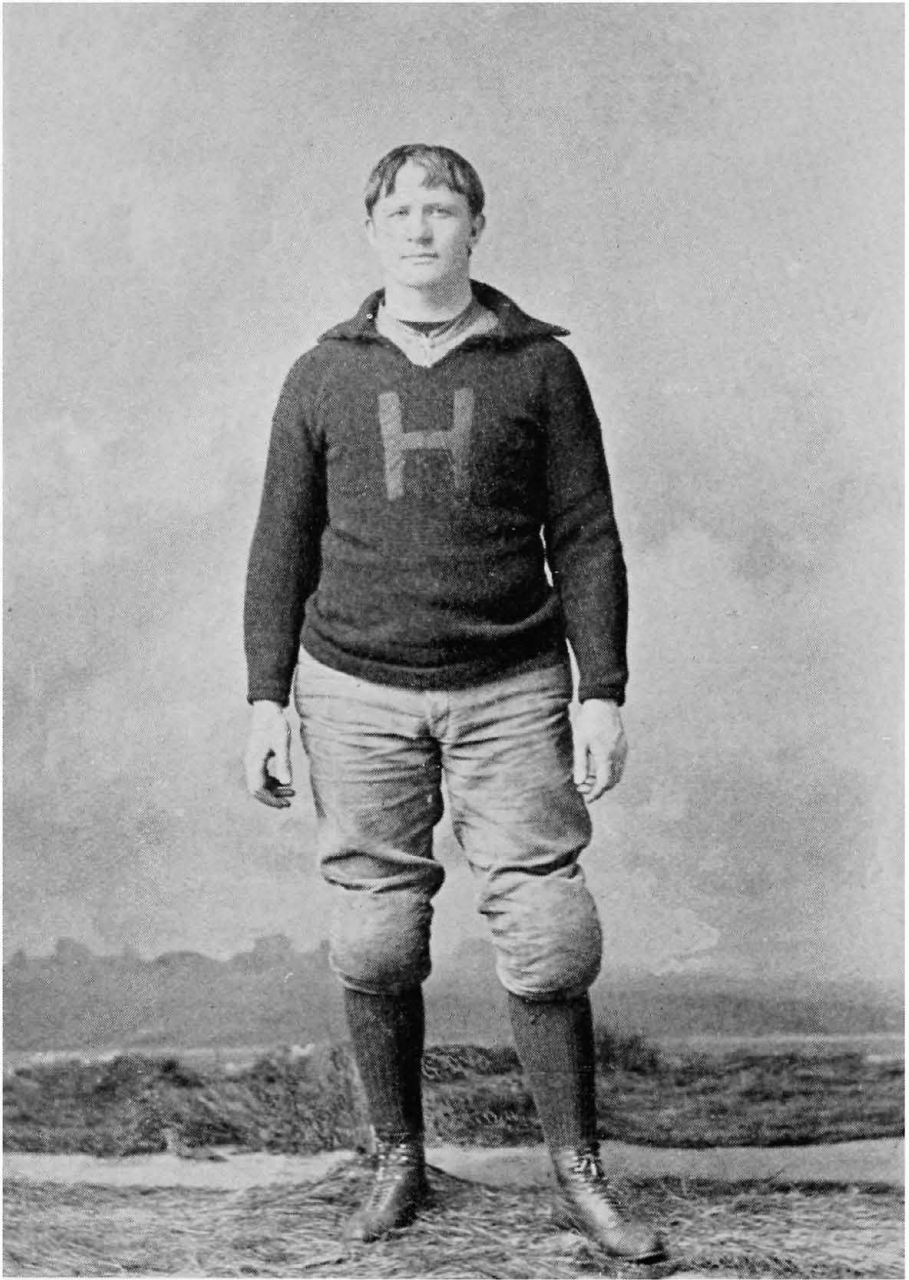

James Parrish Lee.

## HALF-BACK

BY JAMES P. LEE

THE characteristic duty of the half-back in the game of foot-ball is to carry and advance the ball. Other members of the team are, it is true, frequently called upon to run with the ball. Of late years, indeed, the full-back has taken an almost equal share with the half-backs in this respect. But it is a duty which devolves especially upon the half-backs, and the player who can be relied upon for a gain in an emergency possesses one of the first qualifications for the position.

To advance the ball is, however, but one of the several duties of a half-back. A consideration of the subject of half-back play may be divided for convenience into three headings, — individual play, offensive play, and defensive play.

Every man has a distinct duty to perform in each play. If he fails to accomplish it, the failure of the play as a whole may be laid to

him. This is the business of the coach, to teach each player on the team *what* he is expected to do and *how* he is expected to go about it. But before a half-back can fulfil his part in team play, he should be first taught, and then practise, those things which depend upon him alone. In this sense, kicking and catching are examples of individual play. Again, there is a right way and a wrong way to receive the ball from the quarter-back. Of what value is the most elaborately worked out "end-play," if from a failure to properly receive the ball from the quarter, the half-back drops it and is obliged to turn and fall upon it? The play is spoiled at its start. Taking the ball from the quarter should be a matter of instinct with the half-back, and should be continually practised. With the exception of a pass for a kick, the ball should always be received by the half-back while he is in motion. In nearly all cases the pass is almost from hand to hand, or at most the ball is tossed with precision, not thrown with full force, to the runner, who receives it naturally in the path of his run, and while at full speed. In carrying the ball, the arm which covers it should

completely protect it; otherwise it may be knocked from the runner's possession. It is necessary for the half-back to remember also to carry the ball under the arm which is the further from the mass of the opposing players who are trying to tackle him. If, for instance, his opponents are all coming up on his left side, his left arm should be free to ward them off. Thus in going around the left end of the line, the ball should always be carried under the left arm; for the opponents will come up on the runner's right side, and his right arm must be free. For a similar reason, for a run around the right end, or between tackle and end on the right side of the line, the ball is carried under the right arm. The proper methods of starting, warding off, and falling on the ball, are also things which a half-back must practise himself. The three backs stand in a straight line at a distance of about four yards behind the rush line. The full-back is directly behind the centre-rush, and faces the ball; and it is better for both the half-backs also to be slightly inclined towards the centre. The secrecy of the play can in this way be always secured, and the men can watch the ball best

from this position (Plate VII.). As for starting, it is equally easy to start in either direction. Immediately the signal is given, and before the ball is put into play, two mistakes may be made by the backs. The worst of these is to make a false start in the direction in which the play is to go. The other is to yield to the temptation to look simultaneously to the same spot. The effect of either is to destroy the secrecy of the play. A certain tackle once told me that he always noticed the movement of the eyes of the opposing backs when the signal was given. He was seldom mistaken in knowing where the play was to go, and could inform his end-rush and rush-line half-backs to that effect. When the runner is under way, he should remember, in warding off an opponent, to keep his arm in a straight position, otherwise a tackler can easily break down his guard and reach him; but if kept at arm's length, the runner is safe. The straight arm can either be used full on the body of his opponent, or as a pivot around which the half-back may run while he keeps his opponent from him. In falling upon the ball, the great point to remember is to get a secure hold upon it by holding it into the

PLATE VII.

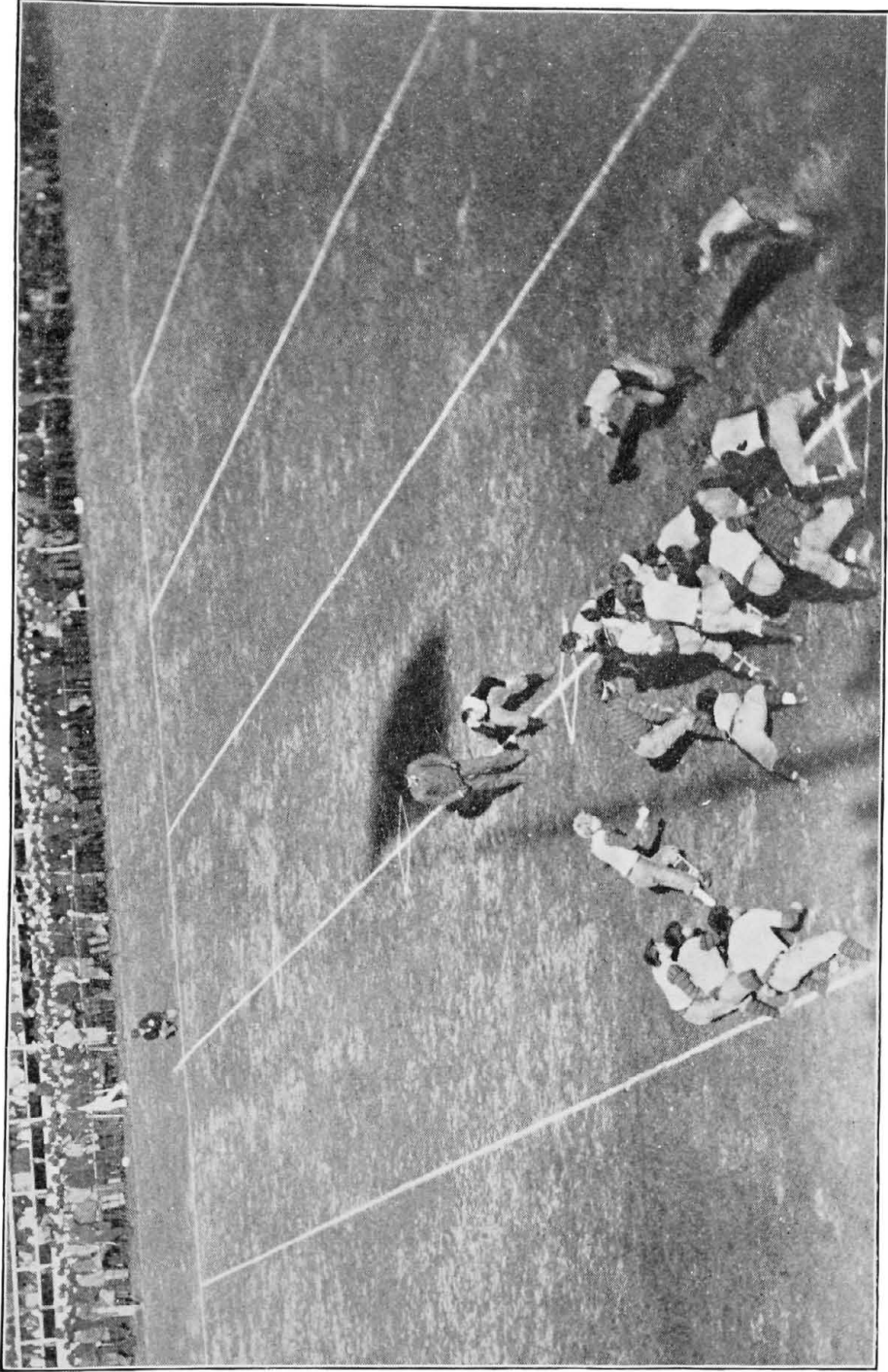

A RUN THROUGH THE LINE

Showing the position of the three backs all "bunched" and their attention concentrated on the ball





body. In no case do the words "possession is nine-tenths of the law" apply more than in the game of foot-ball. The tenth point, the indignant protest of the half-back, that he had the ball "down" before he lost it, is seldom of any avail. Kicking, catching, and tackling are matters of daily practice for the three backs. Of the first two it is sufficient to say that all the candidates for the half-back position should be proficient in them, although they belong in the first place to the full-back's position, and are discussed under that heading. It is of course most important that the half-backs should learn to tackle surely. A method sometimes employed to teach tackling, is the use of a tackling-machine. This consists of a heavy swinging bag, hung within a few inches of the ground by a pulley. As the bag swings forward the tackler goes to meet it. The machine is so constructed that one is obliged to tackle it low, and as it is lifted and thrown backward to the ground, it falls slowly and heavily, owing to the resisting pulley which is used. The machine is also used to teach a man to tackle a runner who has got by him. It is swung in the air, and the tackler follows it

from behind, throwing himself towards it at the proper moment, and taking it low, he goes as though it were a man running at the ball. So much for individual play. As far as space would allow, I have made mention of several important things which a half-back should be proficient in before it is well for him to begin to think of team play. These things should be practised during the spring and summer months, as well as during the foot-ball season; for when the fall comes round, the short season of six or seven weeks is none too long in which to learn the number of plays which are taught to a university team.

Of team play, it may be roughly said, that it is the disposition and use of the eleven men of the team in the manner in which each will be of his greatest value to each play as a whole. This, both to the player and the spectator, is the most interesting element of the game. Each player is taught his distinct duty in every play, and it is in making use of the men where they will tell most in a united effort to advance the ball, that our game is now so far ahead of the English game. This is the scientific part of

foot-ball, and the combinations which can be made are an endless source of study to the captain and the coach.

There are one or two plays which should be mentioned in connection with the question of offensive team play, to show better the part which the half-back takes in the game.

Supposing it is desired to send the right half-back between the centre-rush and right-guard, the hole between centre and guard is apt to be well closed up in any case, and it is inadvisable to crowd it further by sending in one of your own men in an attempt to clear a way for the runner. The runner should go first, the full-back next, and the left half-back third. The three men should be in a straight line and close together; thus when they strike the rush line, they will do so with a force equivalent to the momentum which three men could exercise, and yet in going through the hole they will take up the room of but one man. When the runner strikes the line he should be running fast and low, and should remember that the great point is to get into the line and beyond it quickly. Quickness in the first move of this play is absolutely necessary.

Neither half-back is sent nowadays around his own end of the line. The left half-back is sent around the right end, and the right half-back around the left. In this way the runner can make use naturally of two interferers, — the full-back and the other half-back. In the former method, the half-back alone could be used, and then only by allowing him to go between the quarter-back and the runner after the ball is put into play and before it was passed. This is very clumsy. The full-back would frequently interfere with the pass. To exemplify the duties of the half-backs in the main play, let us take a play around the right end of the line. The right half-back will do well if he clears the end-rush out of the game and follows the play after he has done so. It is essential for an interferer, whether he is a half-back or not, to remember that after he has disposed of his man, he should follow the play. He will be of great use in guarding the rear, for it is from this point that many of the open plays are stopped. The left half-back takes the ball on the right; he is surrounded by blockers-off, whom he should use with intelligence, either by dodging behind them or

putting his hand on the waist of one of them: both ways are useful at different times. It must be remembered that the runner and his interference may travel across the breadth of the field and not gain a foot of ground. It is necessary here, just as in centre plays, for the play to get past the line as soon as possible. It is then only that the gain counts; and if the end-rush is forced out of the game in a play around the end, it is time to cut in immediately and force the run straight up the field. If the runner does not get past the line when he has the opportunity, he is likely to be tackled before he reaches it.

While on the defence, it is recognized now that it is the better mode of play to leave but one man back to guard the field. He should be the surest catch and the best kicker of the three, and it is the place for the full-back. Both half-backs play in the line. The rush-line half-back should take his stand on the defence, just outside his tackle. It should be his special duty to stop plays both inside and outside of the end-rush. But he must be careful not to become so mixed up in the line that he cannot get back immediately to the centre in time to stop all push-plays and

wedges, by falling on the ground in front of them on his own side of the line. If the opponent's play is around the other end of the line, the half-back had better chase it from behind. At a certain point the play will receive a check, owing to contact with those who are attempting to break up the interference. It is at this point that the half-back who chases the play will have the opportunity of catching it and tackling the runner. If the play is to his own end of the line, the rush-line half-back plays as a second tackle; the end-rush drives the play in, and the runner, being forced to turn, runs into the arms of the tackle and half-back, both of whom go to meet the interference immediately on the start of the play. At all times when it appears to be the manifest intention of the enemy to kick, especially upon their third down, one of the half-backs must get back and cover the field with the full-back (see Plate VI.). In such a case these two must play with an entire mutual understanding. When the ball is kicked, the full-back by preference says who shall take the kick; the other backs up in case of a fumble. The blocking off to protect the man catching

the ball must be done by the other half-back and the end-rushers. The advisability of returning the kick depends somewhat upon the respective capabilities of the opposing kicker. If A kicks the ball but forty yards, and B can return it fifty yards, the result, barring accidents, is equivalent to a loss of ten yards by A's team. If, however, a man has the opportunity to return a kick, he has usually the opportunity to make at least a short gain by a run. To do so is in most cases of greater value to his team than to return the kick and suffer the disadvantage of losing the ball.

Let a half-back first practise assiduously to become proficient in every kind of individual play. As to the part which is allotted to him in team play, that, of course, is a matter largely of personal opinion. The half-back should remember this: he should carefully think out for himself the capabilities of his position, and, when off the field, inform the captain of his own opinion. If a man plays in this way with intelligence, not only will his value to the team be practically enhanced, but the game will be of far greater interest to himself. Any endeavor of the individual



to take a whole play into his own hands and throw aside upon the field the part assigned to him in any given move should be stopped the first day of practice. But when that is thoroughly understood, a captain cannot do better than to encourage his men to think for themselves, and to stimulate amongst them in this way a healthy interest in the game.





*W. T. Buee*

## FULL-BACK

BY W. T. BULL

WITHIN the last three years only has the position of full-back assumed a degree of importance second to no other on the team. Once the full-back was selected for the position because of his fine tackling; now he must not only combine the rushing tactics and the interference of the half-backs, but be able to kick as well.

As the interference game has developed and changed the style of play, so have the duties of full-back increased in proportion. Now the full-back is called on to do all the kicking; formerly the half-backs did it. Now he has an assigned place in every play; when the interference game was first introduced, he was never an important figure. The position as played to-day, then, requires not only the proverbial cool head and tackling qualities to maintain the last point of the defence, beyond which scoring becomes almost a

certainty, but the endurance of an iron man in order to get into all plays and keep up the standard of kicking. I say *all* plays, to emphasize the importance of the full-back thinking that he must try to do something at all times, as though his life depended on it.

The position which the full-back assumes gives him the likeliest opportunities for kicking, and for this reason he is selected for this highly important work, and his perfection in this line consequently becomes the first requisite in selecting a player for the place. Next in importance in the selection of a player is aptitude in getting into interference for half-back plays. Then would follow the ability to buck the centre in such an approved style that a small gain of never less than a yard becomes a certainty, barring accident, of course, a mistake in signal, or a fumble.

Treated in the order of their importance, then, as above enumerated, we may get an idea of what the full-back must do in the aggressive game.

Kicking should include not only the ability to punt, but to drop-kick. This, unfortu-

nately, has been fulfilled by few players with any degree of skill, particularly in the latter case. Punting is perhaps more important, in the long run, than drop-kicking, because it becomes necessary more often to employ it.

In punting there are several points to be observed in particular. First, the ability to get the ball away without its being blocked; then to place the ball; and finally to get it just as far down the field as possible and yet within reaching distance of the ends.

To get the ball away without its being blocked, the full-back must be able to kick either from a standstill, or on the run, which becomes necessary in order to dodge first an opposing rusher or two who have broken through the interference.

To place accurately, the player must select the most desirable place *before* receiving the ball; then his experience, attained by long practice, should get it there. Experience will also teach him how much ground his ends can cover, and he should at will be able to kick twenty-five, forty, or fifty yards, as the occasion may require.

The way to acquire versatility in kicking

the ball is to have, in practice, a player rush for the kicker and try to block the ball; and to acquire accuracy in placing, the *only* way is to do in practice always what should be done in a game; that is, before receiving the ball select some object in front, or to the side, and then try to reach it, or make the ball travel in a direct line for it. Let it be the rule whilst practising, to have always a definite object in view; kicking at random is a grave error.

As for the distance to be covered, the practice games will soon teach one just how much force to employ, and in the employment of this force it is necessary to consider the quickness of the opposing rushers in breaking through, and then the wind. In the former case, if they break through slowly, it follows that you can wait until your ends have a start of five yards or more, which distance you will have to add to that which you know your ends capable of overcoming.

As regards the wind, if it be favorable, the ball should be kicked well in the air to allow for the carrying force of the wind; and if against you, a long low kick, which should be well placed. It is most important in this

case to communicate by signals to the ends where that place is to be: particularly is this so when it becomes advisable to kick the ball into "touch," thus making a certainty of having a player or two about the ball when it falls, and increasing as well the chances of securing it should an opponent touch it, or the kicker succeed in putting all on side. But at all times it is well to signal the ends, for by giving them confidence as to just where to run they become faster, cover more ground, and reduce to a minimum the success of a return or a run: this is self-evident.

There are a number of different motions which the kicker may impart to the ball at will,—the revolving motion, where the ball travels as a projectile without tumbling, and the tumbling motion, either forward or backward. These different kicks can be acquired by only the hardest kind of practice, and need no particular instruction. They are to be perfected by years, almost, of experience and hard work. Drop-kicking is, of course, at critical stages of the game, of prime importance. To be successful, a player must be able first of all to get the ball away immediately he receives it from the quarter-back,



and not lose any accuracy thereby. The goal should always be in the mind's eye, and the eye should be only on the ball: this is imperative.

There are so many ways of drop-kicking, all of which have had as many successful performers, that a separate description would take up endless space almost. But whichever way be adopted, whether the ball be dropped on the side by one hand, or whether it be dropped directly in front, the top pointing from or toward the kicker, is a matter of little importance, so that the ball be dropped squarely, without canting to one side, and the toe meets the middle seam squarely, whilst travelling in a straight line, the two cardinal points of which are the middle of the goal and the ball itself. To emphasize this latter point it may prove profitable to remark that in place-kicking for goal this is observed to the letter. If the holder of the ball is reliable, that is to say, he does not permit the ball to change its position when placed on the ground, success is assured. It is necessary, however, to remember in kicking goals the caution given above about keeping the eye on the ball. In sighting the ball

for the goal you fix its exact locality in your mind, then just glue the eye on a certain spot on the middle seam and about midway between the lower part of the lacings and the bottom of the ball,—the very spot, in fact, which experience has taught you, if struck squarely, will yield a goal. Then deliberately make the kick: never hurry, never try to kick with all your might, for accuracy suffers thereby.

In receiving the ball from the quarter-back it should be caught in the hands, not the arms, to save time, and once caught should not be turned and handled before dropping; too much time is always wasted by so doing, and a movement of the arms alone suffices to fix the ball properly: a trial or two will quickly demonstrate this.

Interference play is next to be considered. The position which the full-back assumes relative to the rush line is governed, of course, by the play to be made, but the way to interfere changes. Let these words ever ring in your ears: go at your man *low* and use your shoulder roughly; make it the unexceptional rule to render the first man you strike useless, and then proceed to take another; but *be sure*

*of the first* at all odds, and you have accomplished much for the success of the play.

In runs by the halves, around the ends, the full-back runs a little ahead and to the left for left-end plays, and *vice versa* for right-end plays. In running ahead, care must be taken in gauging your speed so as to keep just in front of the runner, and not allow too much space to intervene.

If ahead, select your man and get him out of the play without fail; then you can follow up behind and protect the runner: if in the rear, follow the runner closely and stick to him whilst guarding off until he is about to be brought to earth, then add your weight to his, keep your feet if possible, and when he falls, you can drag him along a little: a foot may mean a touch-down, and many times, a first down. In centre plays the only interference which can be done to advantage is from the rear, and here again your weight in its entirety should be applied the moment the hole is reached and opposition encountered. "Bucking the centre" is a science which few master. There are two requirements absolutely essential: they are firmness on the feet and

low running. Then follows the ability to get a flying start and strike the hole squarely. The ball may be held under one arm without the least danger of losing it, the free arm being used as a driving-rod to clear the way. Both arms, however, should be about the ball when downed.

Let us now consider the position relative to the other players in the defensive game, or when the opposite side has the ball.

Judgment of the finest and quickest kind and a thorough knowledge of the game now enter and show to their best advantage. Here, too, we obtain the primary idea or meaning of the term "full-back," which is to back up, and in most cases the half-backs are the ones to demand this attention. Once imbued with this idea, the player in the full-back position has learned the first principle of defence. He will, therefore, never permit himself to get in advance of the halves, as for instance, if an opposing left half-back be making for the right end. Instead of darting through the line to tackle him, the full-back will follow up his own left half, and so close that in case the half misses his tackle he will be on the spot to bring the runner down

before he can recover from the shock. When a centre play is made, he will likewise keep in the rear, ever ready to do his work when the halves fail. But, like all rules, there are exceptions, and at times it happens that the full-back has a clean try for the runner, and to let the chance go by would be an error indeed.

This is where judgment is a consideration of quite as much importance as before the play starts. Then he must "size up" the play if possible. If he thinks a kick is contemplated, he must drop back quickly, and, if a line play, he must direct his halves — caution them if necessary — and spur them on with words of encouragement that he is close at hand, ever ready to assist.

Five yards back of and between the halves, is the rule when playing close up to the line to meet running plays, unless one half-back is sent by the captain into the line, in which case he assumes, for the time being, the place vacated. When well back to receive a kick, the full-back should call out the name of the player to take the ball: if himself, then the halves form on either side and a little in the rear, thus forming a tri-

PLATE VIII.

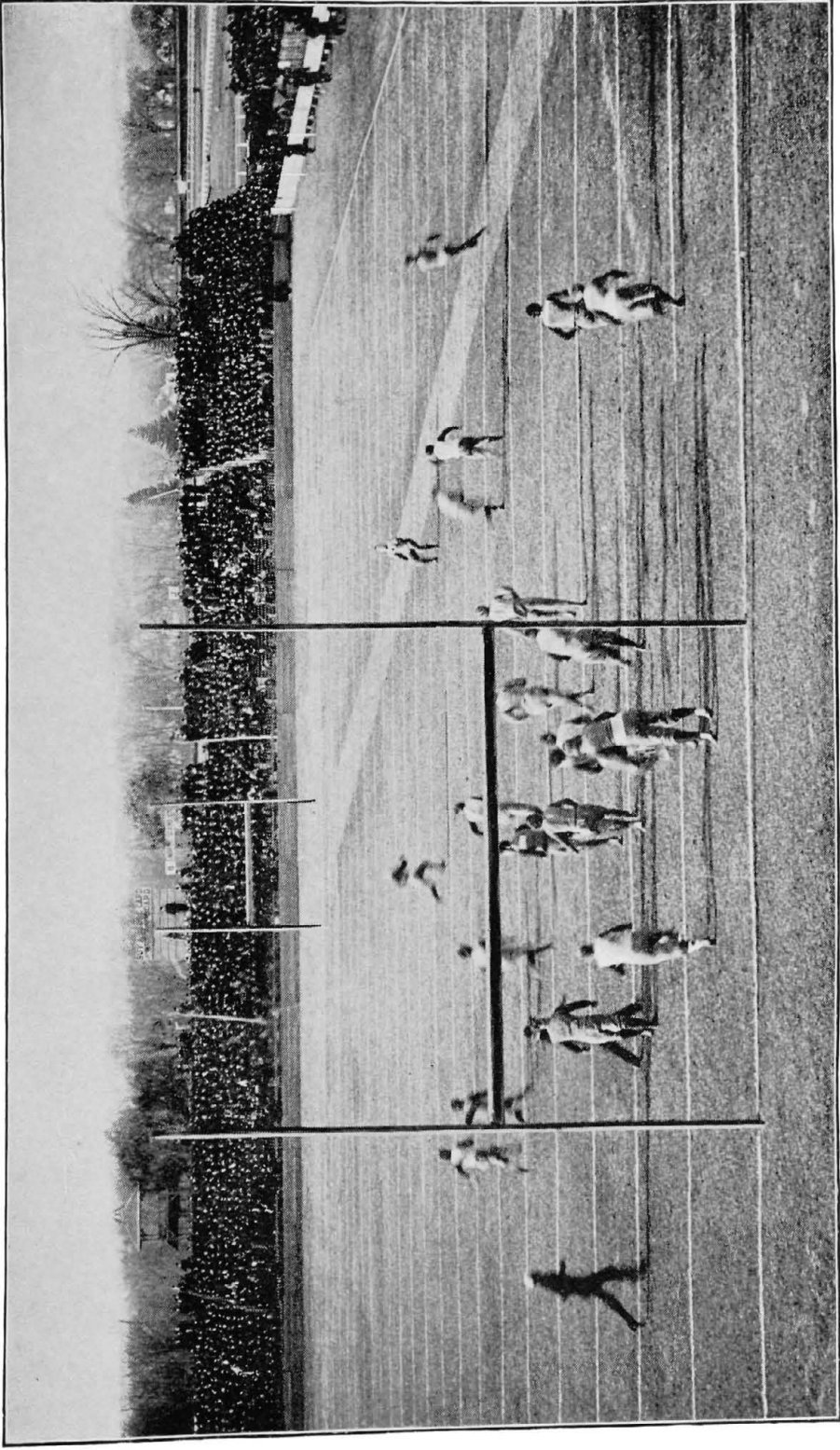

FULL BACK

AFTER A KICK

Illustrating the position of the receiving full back, and the manner in which the end rush goes down the field to shut off a return by a run



angle. If a left half-back, he forms in the rear, to the left of the catcher, and *vice versa*, when the right half-back is to try for the ball. This rule will apply ordinarily; but when it happens that only one opponent gets down the field under the kick, it is advisable for one or both halves to interfere with him, and thus allow the catcher a chance for a return kick or a run.

The slightest opportunity for a run should be seized; and if that be not presented, then a kick resorted to.

In catching the ball from a kick it is well to train yourself to forget all else but the ball. It is impossible to watch the players rushing for you and the ball at the same time (see Plate VIII.).

From what has been said about kicking it must not be inferred that the full-back alone can perform this duty; for it happens at times that a half-back can do it to better advantage, as in the case of a fair catch.

In fact, it would be a step well advanced in the science of the game to have the kicking divided equally between the full-back and one of the halves. At least such a system would make blocked balls less frequent, from



the fact that there would be created a certain amount of indecision on the part of your opponents as to which player to make for.

Of course the same formation would have to be observed, but this could be easily arranged.

At the present time there is one great obstacle in the way: a scarcity of kickers of merit, and the little likelihood of any two players eligible to play on the same team, possessing an equal amount of proficiency. One or the other would surely be so much better that it would be poor policy indeed not to use him altogether.

## TRAINING

PROBABLY no subject connected with athletics has received a more diversified and thorough treatment than the best way of training an individual or a team for some special physical effort.

There are systems without number, each bearing the stamp of individualism, but all resting on the common basis of diet, hygiene, and exercise. The changes may be rung on these according to the views of the trainer, but they are the basic principles, and all methods of physical culture must rest on them for a beginning. The three are so nearly allied in importance that it would be almost impossible to make a distinction in favor of any one: the neglect of one weakens the others, and the three must be employed at the same time to get good results.

Taking a team in the fall, before the men are in good hard shape, the first thing to be done is to cut off the two antagonists to training, — tobacco and alcohol; unless this be

done, subsequent measures are useless. Then light exercise, as "track running," to loosen up the muscles and get a little "wind": after a day or two of this, short halves may be played, the time being gradually increased as the players settle down to their work until full time is reached. Of course the question of diet depends more or less on the financial condition of the organization training its team. It is by far better to have the men under the personal supervision of the captain at each meal, that he may regulate what they eat in accordance with the system adopted.

A simple diet is the one indicated, with a predominance of nitrogenous food, and yet care should be taken that it does not, by lack of variety, become distasteful. In meats, beef, of course, is the staple, since it wears better than any other one, but it may be varied by mutton, chicken, or white-meated game. For vegetables, it is a good rule to have one farinaceous and one green, — potatoes, rice, or hominy, and lettuce (without dressing), spinach, or cresses. The bread should be stale and *light*, baker's bread being preferable on this account.

There is one routine practice which seems

absurd from a medical standpoint; that is the common custom of interdicting coffee, and yet allowing quantities of iced tea or hot tea to be drunk. The active principles of both — namely, caffeine and theine — are identical, save for name, and tea has the disadvantage of being a decided astringent; if one be excluded, the other ought, and coffee is probably in moderation the one to be preferred. Milk is also commonly forbidden, although it is recognized in all diet lists as the nearest approach to an ideal food.

Of latter days there has been, in the writer's opinion, more of a tendency to over-train than not to train enough, and the one fault is as bad as the other. Some men can stand more training than others, and the personal equation should always be taken account of, and each individual watched for the least indication that he is getting too "fine." It should be the business of the trainer to see that the meals are scrupulously clean, and that they are well served, for many men will go hungry rather than eat a "messy" dinner illy prepared.

The mid-day meal should be the heartiest, breakfast and supper of a lighter character.

An allowable diet for a day might comprise some of the following articles: —

**Breakfast, 8 A.M.**

Oat meal, hominy grits, or hominy.  
 Steak, mutton chops, eggs (boiled or poached).  
 Potatoes (baked or stewed).  
 Bread or toast.  
 Milk or coffee.

**Dinner, 12, 1, or 2 P.M.**

A clear soup, oysters (slightly stewed).  
 Beef, mutton, chicken, turkey.  
 Potatoes (baked, boiled, mashed).  
 Tomatoes, rice, hominy, lettuce, spinach.  
 Bread (stale wheaten).  
 A light custard or pudding, apples.  
 Apollinaris.

**Supper, 6 P.M.**

Eggs (poached, boiled).  
 Steak, chops.  
 Bread, milk toast.  
 Apple sauce, prunes.  
 Tea, milk.

As for hygiene, the same rules which apply under any other conditions are sound here. Plenty of sleep, good ventilation, absence of nervous strain or worry, and good care of the skin by massage or "rubbing down." Combining the three elements

of exercise, diet, and hygiene, for a day we should have a schedule on the order of the following:—

Rise at 7 A.M., breakfast at 8.

Exercise (the heaviest before the mid-day meal).

Rub down with whiskey and water and towels after exercise.

Dinner, 12, 1, or 2.

Light exercise, passing ball, kicking, practising "tricks."

Supper at 6.

To bed at 10, in a cool room, in a quiet place, only one man in a bed.

Of course there is infinitely more that might be said on the subject; but as it is capable of such a wide range of variation, and since it starts on such a common-sense foundation, it ought not to be difficult for any captain or coach to formulate for himself a perfectly satisfactory method.



## THE REFEREE AND UMPIRE.

UNLESS one is familiar, thoroughly familiar, with the game ; unless one has a good memory, a quick eye, and cool head ; above all else, unless one has the ability to give a decision on a close point with the utmost fairness and without the least suspicion of bias, — the best advice on the subject is that which *Punch* gave to people thinking of marrying, — “Don’t !”

It seems a very easy thing to decide on the field whether a ball be “down” at one spot or four feet away from that place ; whether a gain of five yards has been made, or only three ; whether a man has muffed a punt, or lost it through wanton interference : all these things, to the onlooker in a match game, seem easy and plain, yet there is no duty which requires more painstaking carefulness and attention than that of the judges in a contest.

It looks simple, and seems easy ; yet it is



strange how many men, and old foot-ball players too, will give decisions which are much in discord with the facts of the play.

If one is to serve either as referee or umpire at a known date ahead, it is a good plan to practise for it, as he would if he were to play instead of give decisions. Nothing will quicken his perceptions more, nor show him more surely on what points he is hazy, than the actual fact of having them brought before him in scrub games for a ruling. Aside from this, there are points which are not covered definitely by the rules, and these he must get at by exclusion and the benefit of former decisions as a precedent. For instance, suppose a fair catch be made, and the catcher place the ball on the ground, without claiming either a fair catch or a down; is the ball in play, or not? It has been claimed that it is, since, in a fair catch, it is in play as soon as it touches earth; and it has been decided that it is not, since the rules state only two ways of playing from a catch, — drop-kick with its modifications of place-kick and dribble, and a down: it has also been ruled that the ball has been played, and the side holding it has made a down.

Many things of this kind may come up, and the only way to be prepared to meet them is to have gone over them in practice. Do not despise the rule-book. Familiarity with its contents may save many a vexatious minute of hunting for a rendering all of which you can remember is "that it is somewhere on the right-hand page near the bottom."

Before starting in a game, it is well for the referee and umpire to confer and determine just what part of the decisions each understands as belonging to his province.

One of the most annoying things connected with the referee's duties is to have a multiplicity of captains on the field, each one of whom feels himself privileged to make claims and kick on decisions; if allowed, it will confuse and rattle the coolest man. It is well to take it at the start and state firmly, emphatically, and finally that protests from the captains *only* will be received, and then proceed on that basis.

Always make up your mind fully on a point before giving a decision, and when it is once given, let it stand. Your authority is final, and few times will any decided protest be made in the face of a firm ruling unless it

be manifestly wrong. Some captains always start out with the design of browbeating the referee and umpire. If they succeed, so much more advantage for their team; if not, they generally stop and play foot-ball.

With a cool head, a mind of his own, a knowledge of the game, and no interest in either team, it ought not to be a difficult matter to referee or umpire for any twenty-two men who can abide by honest, square decisions.

**RULES AND CONSTITUTION**

**OF THE**

**AMERICAN INTERCOLLEGIATE ASSOCIATION**



RULES AND CONSTITUTION  
OF THE  
AMERICAN INTERCOLLEGIATE ASSOCIATION

---

RULE 1. — (a) A drop-kick is made by letting the ball fall from the hands and kicking it at the very instant it rises.

(b) A place-kick is made by kicking the ball after it has been placed on the ground.

(c) A punt is made by letting the ball fall from the hands and kicking it before it touches the ground.

(d) Kick-off is a place-kick from the centre of the field of play, and cannot score a goal.

(e) Kick-out is a drop-kick, or place-kick, by a player of the side which has touched the ball down in their own goal, or into whose touch-in-goal the ball has gone, and cannot score a goal. (See Rules 32 and 34.)

(f) A free-kick is one where the opponents are restrained by rule.

RULE 2. — (a) In touch means out of bounds.

(b) A fair is putting the ball in play from touch.

RULE 3. — A foul is any violation of a rule.

Touch in Goal.	<p style="text-align: center;">In Goal.</p> <p>Goal Line.                      Goal Line.</p> <p style="text-align: center;">(18½ feet)</p>	Touch in Goal.
<p style="text-align: center;">In Touch.</p> <p style="text-align: center;">330 feet.</p> <p style="text-align: center;">Touch or Bounds.</p>	<p style="text-align: center;">25-yard-line Limit of Kick-out.</p> <hr/> <p style="text-align: center;">25-yard-line Limit of Kick-out.</p> <hr/> <p style="text-align: center;">160 feet.</p> <p style="text-align: center;">( Goal. )</p>	<p style="text-align: center;">Touch or Bounds.</p> <p style="text-align: center;">330 feet.</p> <p style="text-align: center;">In Touch.</p> <p style="text-align: center;">Touch or Bounds.</p>
Touch in Goal.	<p style="text-align: center;">In Goal.</p> <p>Goal Line.                      Goal Line.</p> <p style="text-align: center;">(18½ feet)</p>	Touch in Goal.

**RULE 4.** — (a) A touch-down is made when the ball is carried, kicked or passed across the goal line and there held, either in goal or touch-in-goal; the ball to be brought out from the place called "down," not the place where it crosses the goal line.

**NOTE.** — The Ball adopted and used exclusively by the American Intercollegiate Association is the "Spalding J." Ball, made by A. G. SPALDING & BROS., and to be genuine must bear their Trade Mark.

(b) A safety is made when a player guarding his goal receives the ball from a player of his own side, either by a pass, kick, or a snap-back, and then touches it down behind his goal line, or when he himself carries the ball across his own goal line and touches it down, or when he puts the ball into his own touch-in-goal, or when the ball, being kicked by one of his own side, bounds back from an opponent across the goal line, and he then touches it down.

(c) A touch-back is made when a player touches the ball to the ground behind his own goal, the impetus which sent the ball across the line having been received from an opponent.

**RULE 5.** — A punt-out is a punt made by a player of the side which has made a touch-down in their opponents' goal to another of his own side for a fair catch.

**RULE 6.** — A goal may be obtained by kicking the ball in any way except a punt from the field of play (without touching the ground, or dress, or person of any player after the kick) over the cross-bar or post of opponents' goal.



**RULE 7.** — A scrimmage takes place when the holder of the ball puts it down on the ground, and puts it in play by kicking it or snapping it back.

**RULE 8.** — A fair catch is a catch made direct from a kick by one of the opponents, or from a punt-out by one of the same side, provided the catcher made a mark with his heel at the spot where he has made the catch, and no other of his side touch the ball. If the catcher, after making his mark, be deliberately thrown to the ground by an opponent, he shall be given five yards, unless this carries the ball across the goal line.

**RULE 9.** — Charging is rushing forward to seize the ball or tackle a player.

**RULE 10.** — Interference is using the hands or arms in any way to obstruct or hold a player who has not the ball. This does not apply to the man running with the ball.

**RULE 11.** — The ball is dead :

I. When the holder has cried down, or when the referee has cried down, or when the umpire has called foul.

II. When a goal has been obtained.

III. When it has gone into touch, or touch-in-goal, except for punt-out.

IV. When a touch-down or safety has been made.

V. When a fair catch has been heeled. No play can be made while the ball is dead, except to put in play by rule.

**RULE 12.** — The grounds must be 330 feet in length and 160 feet in width, with a goal placed in the middle of each goal line, composed of two upright posts, ex-

ceeding 20 feet in height, and placed 18 feet 6 inches apart, with cross-bar 10 feet from the ground.

RULE 13.— The game shall be played by teams of eleven men each; and in case of a disqualified or injured player a substitute shall take his place. Nor shall the disqualified or injured player return to further participation in the game.

RULE 14.— There shall be an umpire and a referee. No man shall act as an umpire who is an alumnus of either of the competing colleges. The umpires shall be nominated and elected by the Advisory Committee. The referee shall be chosen by the two captains of the opposing teams in each game, except in case of disagreement, when the choice shall be referred to the Advisory Committee, whose decision shall be final. All the referees and umpires shall be permanently elected and assigned on or before the third Saturday in October in each year.

RULE 15.— (a) The umpire is the judge for the players, and his decision is final regarding fouls and unfair tactics.

(b) The referee is judge for the ball, and his decision is final in all points not covered by the umpire.

(c) Both umpire and referee shall use whistles to indicate cessation of play on fouls and downs. The referee shall use a stop watch in timing the game.

(d) The umpire shall permit no coaching, either by substitutes, coaches, or any one inside the ropes. If such coaching occur, he shall warn the offender, and upon the second offence must have him sent behind the ropes for the remainder of the game.

RULE 16. — (a) The time of a game is an hour and a half, each side playing forty-five minutes from each goal. There shall be ten minutes' intermission between the two halves. The game shall be decided by the score of even halves. Either side refusing to play after ordered to by the referee, shall forfeit the game. This shall also apply to refusing to commence the game when ordered to by the referee. The referee shall notify the captains of the time remaining not more than ten nor less than five minutes from the end of each half.

(b) Time shall not be called for the end of a three-quarter until the ball is dead; and in the case of a try-at-goal from a touch-down the try shall be allowed. Time shall be taken out while the ball is being brought out either for a try, kick-out, or kick-off.

RULE 17. — No one wearing projecting nails or iron plates on his shoes, or any metal substance upon his person, shall be allowed to play in a match. No sticky or greasy substance shall be used on the person of players.

RULE 18. — The ball goes into touch when it crosses the side line, or when the holder puts part of either foot across or on that line. The touch line is in touch and the goal line in goal.

RULE 19. — The captains shall toss up before the commencement of the match, and the winner of the toss shall have his choice of goal or of kick-off. The same side shall not kick-off in two successive halves.

RULE 20. — The ball shall be kicked off at the beginning of each half; and whenever a goal has been

obtained, the side which has lost it shall kick off. (See Rules 32 and 34.)

**RULE 21.** — A player who has made and claimed a fair catch shall take a drop-kick, or a punt, or place the ball for a place-kick. The opponents may come up to the catcher's mark, and the ball must be kicked from some spot behind that mark on a parallel to touch line.

**RULE 22.** — The side which has a free-kick must be behind the ball when it is kicked. At kick-off the opposite side must stand at least ten yards in front of the ball until it is kicked.

**RULE 23.** — Charging is lawful for opponents if a punter advances beyond his line, or in case of a place-kick, immediately the ball is put in play by touching the ground. In case of a punt-out not till ball is kicked.

**RULE 24.** — (a) A player is put off side, if, during a scrimmage, he gets in front of the ball, or if the ball has been last touched by his own side behind him. It is impossible for a player to be off side in his own goal. No player when off side shall touch the ball, or interrupt, or obstruct opponent with his hands or arms until again on side.

(b) A player being off side is put on side when the ball has touched an opponent, or when one of his own side has run in front of him, either with the ball, or having touched it when behind him.

(c) If a player when off side touches the ball inside the opponents' five-yard line, the ball shall go as a touch-back to the opponents.

**RULE 25.** — No player shall lay his hands upon, or interfere by use of hands or arms, with an opponent, unless he has the ball. The side which has the ball can only interfere with the body. The side which has not the ball can use the hands and arms, as heretofore.

**RULE 26.** — (a) A foul shall be granted for intentional delay of game, off side play, or holding an opponent, unless he has the ball. No delay arising from any cause whatsoever shall continue more than five minutes.

(b) The penalty for fouls and violation of rules, except otherwise provided, shall be a down for the other side; or if the side making the foul has not the ball, five yards to the opponents.

**RULE 27.** — (a) A player shall be disqualified for unnecessary roughness, hacking, or striking with closed fist.

(b) For the offences of throttling, tripping up, or intentional tackling below the knees, the opponents shall receive twenty-five yards, or a free-kick, at their option. In case, however, the twenty-five yards would carry the ball across the goal line they can have half the distance from the spot of the offence to the goal line, and shall not be allowed a free-kick. •

**RULE 28.** — A player may throw or pass the ball in any direction except towards opponents' goal. If the ball be batted in any direction or thrown forward, it shall go down on the spot to opponents.

**RULE 29.** — If a player when off side interferes with an opponent trying for a fair catch, by touching him or the ball, or waving his hat or hands, the opponent

may have a free-kick, or down, where the interference occurred.

RULE 30. — (a) If a player having the ball be tackled and the ball fairly held, the man so tackling shall cry "held," the one so tackled must cry "down," and some player of his side put it down for a scrimmage. The snapper back and the man opposite him cannot pick out the ball with the hand until it touch a third man; nor can the opponents touch the ball until it is in motion. The opposing snapper back is entitled to no part of the ball and cannot touch the ball till put in motion: the penalty being five yards to the side which has the ball. If the snapper back be off side in the act of snapping back, the ball must be snapped again, and if this occurs three times on same down, the ball goes to opponents. The man who first receives the ball when snapped back from a down, or thrown back from a fair, shall not carry the ball forward under any circumstances whatever. If, in three consecutive fairs and downs, unless the ball cross the goal line, a team shall not have advanced the ball five or taken it back twenty yards, it shall go to the opponents on spot of fourth. "Consecutive" means without leaving the hands of the side holding it, and by a kick giving opponents fair and equal chance of gaining possession of it. When the referee, or umpire, has given a side five yards, the following down shall be counted the first down.

(b) The man who puts the ball in play in a scrimmage cannot pick it up until it has touched some third man. "Third man" means any other player than the one putting the ball in play and the man opposite him.

RULE 31.— If the ball goes into touch, whether it bounds back or not, a player on the side which touches it down must bring it to the spot where the line was crossed, and there either

I. Bound the ball in the field of play, or touch it in with both hands, at right angles to the touch line, and then run with it, kick it, or throw it back; or

II. Throw it out at right angles to the touch line; or

III. Walk out with it at right angles to touch line any distance not less than five nor more than fifteen yards, and there put it down, first declaring how far he intends walking. The man who puts the ball in must face field or opponents' goal, and he alone can have his foot outside touch line. Any one, except him, who puts his hands or feet between the ball and his opponents' goal is off side. If it be not thrown out at right angles, either side may claim it thrown over again, and if it fail to be put in play fairly in three trials, it shall go to the opponents.

RULE 32.— A side which has made a touch-down in their opponents' goal *must* try at goal, either by a place-kick or a punt-out. If the goal be missed, the ball shall go as a kick-off at the centre of the field to the defenders of the goal.

RULE 33.— (a) If the try be by a place-kick, a player of the side which has touched the ball down shall bring it up to the goal line, and making a mark opposite the spot where it was touched down, bring it out at right angles to the goal line such distance as he thinks proper, and there place it for another of his

side to kick. The opponents must remain behind their goal line until the ball has been placed on the ground.

(b) The placer in a try-at-goal may be off-side or in touch without vitating the kick.

RULE 34. — If the try be by a punt-out, the punter shall bring the ball up to the goal line, and making a mark opposite the spot where it was touched down, punt-out from any spot behind line of goal and not nearer the goal post than such mark, to another of his side, who must all stand outside of goal line not less than fifteen feet. If the touch-down was made in touch-in-goal, the punt-out shall be made from the intersection of the goal and touch lines. The opponents may line up anywhere on the goal line, except space of five feet on each side of punter's mark, but cannot interfere with punter, nor can he touch the ball after kicking it until it touch some other player. If a fair catch be made from a punt-out, the mark shall serve to determine positions as the mark of any fair catch. If a fair catch be not made on the first attempt, the ball shall be punted over again, and if a fair catch be not made on the second attempt, the ball shall go as a kick-off at the centre of the field to the defenders of the goal.

RULE 35. — A side which has made a touch-back or a safety must kick out, except as otherwise provided (see Rule 32), from not more than twenty-five yards outside the kicker's goal. If the ball go into touch before striking a player, it must be kicked out again ; and if this occurs three times in succession, it shall be



given to opponents as in touch on twenty-five-yard line on side where it went out. At kick-out opponents must be on twenty-five-yard line or nearer their own goal.

RULE 36. — The following shall be the value of each point in the scoring : —

Goal obtained by touch-down, . . . . .	6
Goal from field-kick, . . . . .	5
Touch-down failing goal, . . . . .	4
Safety by opponents, . . . . .	2

## *CONSTITUTION*

### ARTICLE I.

The name of this Association shall be the American Intercollegiate Foot-Ball Association.

### ARTICLE II.

SECTION 1. This Association shall consist of Yale, Princeton, Wesleyan, and the University of Pennsylvania.

SEC. 2. No college shall be admitted to membership except by an unanimous vote.

SEC. 3. The annual assessment shall be \$25 from each college, and out of the total sum \$75 shall be expended for a Championship Pennant.

SEC. 4. Any college failing to pay the annual assessment on or before December 1st of each year shall forfeit its membership in the Association.

### ARTICLE III.

SECTION 1. The officers shall consist of a President, a Secretary, and a Treasurer. The Presidency shall be held by the college last holding the championship. The Secretary and Treasurer shall be elected by ballot. The Secretary shall call meetings subject to the order

of the President, and shall preserve the minutes of the meetings in a book.

SEC. 2. There shall be a graduate Advisory Committee of four; one member being elected by the Alumni, or appointed by the Faculty of each of the colleges in the Association.

SEC. 3. This Advisory Committee shall meet and propose the rules, or changes in the same, on the first Saturday in March in each year, and shall submit the said proposed rules or changes to the Secretary of the Intercollegiate Association on or before the first Saturday in April, to be forthwith transmitted by him to the respective college Associations before the spring meeting of the Intercollegiate Association, to occur on the first Saturday in May. At that meeting the said proposed rules or changes shall be acted upon, and be returned by the Intercollegiate Association, with its approval or disapproval, to the Advisory Committee at its summer meeting, to occur on the day of the Intercollegiate Track Athletic meeting in May. Those rules or changes approved shall forthwith take effect; those disapproved shall go over for consideration until the following spring, unless they shall receive three votes in the Advisory Committee, in which case they shall immediately take effect.

SEC. 4. Each of the four members of the Advisory Committee shall have a full vote. Any one may vote and act by representative with a written proxy. Three members of the committee shall constitute a quorum.

SEC. 5. At the written request of any two members of the Advisory Committee or delegates of the Intercollegiate Association, the secretary of the committee

shall convene a meeting both of the Advisory Committee and Intercollegiate Association, but the same shall be only on a five days' written notice to the various members and delegates, which notice must contain a statement of the object of the said meetings. The meetings of the present year shall be governed by this section.

SEC. 6. There shall be an umpire and a referee. The referee shall judge for the ball, and the umpire for the player. No man shall act as an umpire who is an alumnus of either of the competing colleges. The umpires shall be nominated and elected by the Advisory Committee. The referee shall be chosen by the two captains of the opposing teams in each game, except in case of disagreement, when the choice shall be referred to the Advisory Committee, whose decision shall be final. All referees and umpires shall be permanently elected and assigned on or before the third Saturday in October of each year.

SEC. 7. The Advisory Committee shall act as a Committee of Appeals, and shall hold its regular annual session on the third Saturday in October of each year, at which time it shall hear and finally determine any appeal, which must be in writing, from a decision or determination which substantially affects the interpretation or construction of any provision of the Constitution, or of the Rules of the Association, during the year preceding; but this section shall not be construed as affecting any question of fact, the determination of which rests in the discretion of the referee.

## ARTICLE IV.

SECTION 1. The series shall consist of one game with each college, and shall be played upon grounds mutually agreed upon.

SEC. 2. The two leading colleges of the preceding year shall play in or near New York.

SEC. 3. The Championship shall be decided by the greatest number of games won. In case of a tie in games won, the team losing the fewest games shall have the championship.

SEC. 4. In case there is a tie for second place in the championship series, the record of the previous year shall determine which of the two colleges so tying shall play with the champions in New York, according to the provisions of Section 2 of this article.

## ARTICLE V.

In all the championship games the net receipts shall be equally divided between the contesting colleges.

## ARTICLE VI.

Any team failing to meet its engagements shall, unless the failure be caused by unavoidable accident in travelling, or by postponement with the consent in writing of the other team, forfeit its membership. Any college failing to put a team in the field each year shall forfeit its membership. A certificate signed by three members of the Faculty shall be considered sufficient excuse for failure to play.

ARTICLE VII.

There shall be two meetings of this Association, one to be held on the first Saturday in May, the other on the first Saturday in October.

ARTICLE VIII.

The printing of the Rules and Constitution shall be done by the Secretary of the Advisory Committee, and fifty copies shall be forwarded by the Secretary to each college of the Association free of charge.

ARTICLE IX.

No man shall play more than five years in this Association.

ARTICLE X.

No professional athlete shall take part in any contest of this Association, nor shall any player of any university or college be paid or receive, directly or indirectly, any money or financial concession or emolument as present or past compensation for, or as prior consideration or inducement to playing, whether the same be received from, or paid by, or at the instance of the Foot-Ball Association, athletic committee or faculty of such university or college, or any individual whatsoever. And any player who is specifically challenged under this section by any member of the Association in writing, shall, within five days after the filing of such challenge with the secretary, file

with the secretary of the committee an affidavit, duly verified under oath, showing that he in no way violates the provisions of this section, and upon his failure to make and file such affidavit he shall be barred from participating in any contest with the members of this Association. And in case the sufficiency of such affidavit be questioned by the challenging party, and the Committee of Appeals be notified thereof, the player challenged shall submit to oral examination on two days' notice by said challenging party before said committee, who shall then and thereafter decide regarding the eligibility of said challenged player to take part in contests of members of the Association. The date of such examination shall not be set on the day of nor within forty-eight hours of a championship game. No challenge or protest shall in any way affect a game which has been played previous to the filing of such challenge or protest. Furthermore, no one shall be eligible to take part as a player in any championship games of this Association who is not a *bona fide* student of the college on whose team he plays, matriculated for the then current college year, and regularly pursuing a course which requires his attendance upon at least five lectures or recitations a week; and in case a player's qualifications are questioned, he shall furnish to the Advisory Committee a certificate, signed by three members of the Faculty, stating that he is a *bona fide* student, matriculated for the then current college year, and regularly pursuing a course which requires his attendance upon at least five lectures or recitations a week; and the player shall further furnish to the Advisory Committee an affidavit stating that

he is a *bona fide* student of the college in whose team he plays, matriculated for the then current college year, and regularly pursuing a course which requires his attendance upon at least five recitations and lectures a week, and that it is his intention to continue in said course until the expiration of the then current college year.

ARTICLE XI.

A majority vote shall be necessary to pass any vote and a two-thirds vote to amend this Constitution.